

FOUR ZONE INTEGRATED MIXER AMPLIFIER MODELS 46-80 and 46-80T

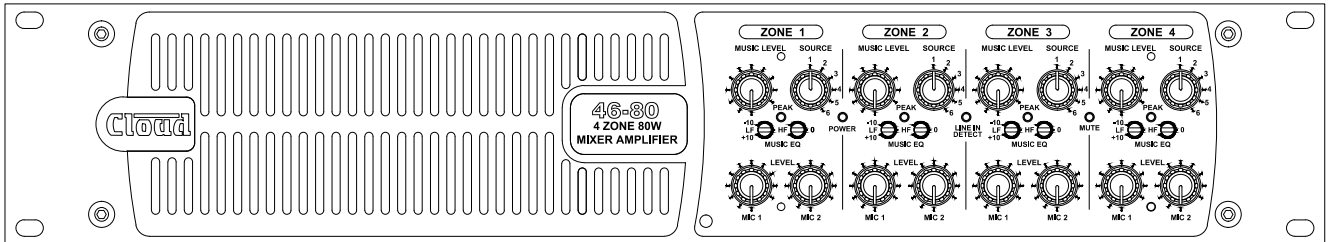



Installation and User Guide

WARNING:

To reduce the risk of fire or electric shock, do not expose this appliance to rain or moisture.

CAUTION:

Use of controls or adjustments or performance of procedures other than those specified may result in hazardous radiation exposure.

	<p>WARNING: SHOCK HAZARD – DO NOT OPEN AVIS: RISQUE DE CHOC ELECTRIQUE – NE PAS OUVRIR</p>
	<p>The lightning flash with the arrowhead symbol within an equilateral triangle, is intended to alert you to the presence of uninsulated dangerous voltages within the product’s enclosure that may be of sufficient magnitude to constitute a risk of electric shock.</p>
	<p>The exclamation point within an equilateral triangle is intended to alert the user to the presence of important operating and maintenance (servicing) instructions in the literature accompanying the appliance.</p>

IMPORTANT SAFETY INSTRUCTIONS

1. Read these Instructions.
2. Keep these Instructions.
3. Heed all Warnings.
4. Follow all Instructions.
5. Do not use this apparatus near water.
6. Clean only with a dry cloth.
7. Do not block any ventilation openings. Install in accordance with the manufacturer's instructions.
8. Do not install near any heat sources such as radiators, heat registers, stoves or other apparatus (including amplifiers) that produce heat.
9. Do not defeat the safety purpose of the polarized or grounding - type plug. A polarized plug has two blades with one wider than the other. A grounding type plug has two blades and a third grounding prong. The wide blade or the third prong are provided for your safety. When the provided plug does not fit into your outlet, consult an electrician for replacement of the obsolete outlet..
10. Protect the power cord from being walked on or pinched particularly at plugs, convenience receptacles, and the point where they exit from the apparatus.
11. Only use attachments/accessories specified by the manufacturer.
12.  Use only with the cart, stand, tripod, bracket or table specified by the manufacturer or sold with the apparatus, when a cart is used, use caution when moving the cart/apparatus combination to avoid injury from tip-over.
13. Unplug this apparatus during lightning storms or when unused for long periods of time.
14. Refer all servicing to qualified service personnel. Servicing is required when the apparatus has been damaged in any way, such as power-supply cord or plug is damaged, liquid has been spilled or objects have fallen into the apparatus, the apparatus has been exposed to rain or moisture, does not operate normally, or has been dropped.



Do not expose the apparatus to dripping or splashing, and ensure that no objects filled with water, such as vases, are placed on the apparatus.

L'appareil ne doit être exposé aux écoulements ou aux éclaboussures et aucun objet ne contenant de liquide, tel qu'un vase, ne doit être placé sur l'appareil.



The mains plug is used as the disconnect device and it should remain readily accessible during intended use. In order to isolate the apparatus from the mains, the mains plug should be completely removed from the mains outlet socket.

Le prise du secteur ne doit pas être obstruée ou doit être facilement accessible pendant son utilisation. Pour être complètement déconnecté de l'alimentation d'entrée, la prise doit être débranchée du secteur.



This apparatus is of Class 1 construction and must only be connected to a mains outlet socket with a protective earthing connection.



Terminals marked with the ⚡ symbol may use Class 2 Wiring, but voltages at these terminals may be of sufficient magnitude to constitute a risk of electric shock. The external wiring connected to these terminals requires installation by an instructed person or the use of pre-made leads or cords.

Contents

IMPORTANT SAFETY INSTRUCTIONS	3
SAFETY INFORMATION	6
Safety Notes regarding Installation	6
Conformities.....	6
Safety Considerations and Information.....	6
Caution – High Voltage	6
Caution – Mains Fuse	6
Caution – Servicing.....	6
OVERVIEW	7
Introduction.....	7
Scope of this manual	7
What’s in the box.....	7
46-80 Main features	8
Optional system components	8
LM-2 remote active module.....	8
BT-1 Bluetooth wireless audio module	8
M-1 Series Remote Mic Input module	9
L-1 Series Remote Line Input module	9
RL-1 Series Remote Music Level Controls.....	9
RSL-6 Series Remote Music Level/Source Controls	9
PM Series microphones.....	10
Block Diagram.....	11
Front panel description.....	12
Rear panel description.....	13
INSTALLATION	15
Hardware considerations.....	15
Ventilation	15
Power Supply.....	15
Fuses and ratings	15
System connections.....	15
Music sources.....	15
Microphone inputs	16
Paging system connections	16
Remote music control.....	18
Zone 1 Facility Port.....	19
Speaker outputs (Lo-Z)	20
Speaker outputs (70/100 V-line operation).....	20
Utility/Loop output.....	20
Auxiliary line outputs.....	20
Music Mute.....	21

RS232 Serial Port	21
SETTING UP & OPERATION	22
Music Inputs	22
Gain & level.....	22
Local/remote control.....	22
Microphone input.....	22
Phantom power.....	22
Gain & level.....	22
EQ.....	22
High-pass filter.....	22
Paging and Priority Settings.....	23
Mic-over-Music priority.....	23
Paging mode.....	23
Line 6 priority.....	23
Mic-over-Facility Port priority.....	23
Zone outputs.....	23
EQ.....	23
High-pass filters	24
Zone Routing (using output stages in parallel).....	24
Utility/Loop Output	24
Auxiliary Outputs.....	25
Auto Power Down.....	25
46-80 SERIAL CONTROL	26
Abridged command set.....	26
OPTIONS AND ADDITIONAL INFORMATION	28
RL-1 and RSL-6 Series remote control plates – general considerations	28
Control of music source and level via external DC.....	28
Using the Facility Port as an auxiliary zone input	29
Fitting CXL-80T transformers	29
APPENDIX.....	30
PCB jumper locations.....	30
Table of internal jumpers and default settings.....	31
Restoring factory settings	31
Summary of rear panel DIP switch functions.....	32
EMC considerations.....	33
Ground loops	33
TECHNICAL SPECIFICATIONS	34

SAFETY INFORMATION

Safety Notes regarding Installation

- Do not expose the unit to water or moisture.
- Do not expose the unit to naked flames.
- Do not block or restrict any air vent.
- Do not operate the unit in ambient temperatures above 35°C
- Do not touch any part or terminal carrying the hazardous live symbol ⚡ while power is supplied to the unit.
- Do not perform any internal adjustments unless you are qualified to do so and fully understand the hazards associated with mains-operated equipment.
- The unit has no user-serviceable parts. Refer servicing to qualified service personnel.
- If the moulded plug is cut off the AC power lead for any reason, the discarded plug is a potential hazard and should be disposed of in a responsible manner.

Conformities

This product conforms to the following European EMC Standards:

BS EN 55133:2017 (Immunity)

BS EN 55032:2015 (Emissions)

BS EN 61000-3-2:2014 (Harmonics)



This product has been tested for use in commercial and light industrial environments. If the unit is used in controlled EMC environments, the urban outdoors, heavy industrial environments or close to railways, transmitters, overhead power lines, etc., the performance of the unit may be degraded.

The product conforms to the following European electrical safety standard:

BS EN 62368:2014

Safety Considerations and Information

The Cloud 46-80 must be earthed. Ensure that the mains power supply provides an effective earth connection using a three-wire termination.

Caution – High Voltage

Do not touch any part or terminal carrying the hazardous live symbol ⚡ while power is applied to the unit. Terminals to which the hazardous live symbol refers require installation by a qualified person.

Caution – Mains Fuse

The 46-80 contains no user-replaceable fuses. Mains over-current protection is provided by the fuse in the IEC receptacle; only replace this fuse with one of an identical type and rating.

If the replacement fuse blows immediately it indicates that the mixer amplifier has developed a fault, which should be referred to competent service personnel.

Caution – Servicing

The unit contains no user-serviceable parts. Refer servicing to qualified personnel. Do not perform servicing unless you are qualified to do so. Disconnect the power cable from the unit before removing the top panel and do not make any internal adjustments with the unit switched on. Only reassemble the unit using bolts/screws identical to the original parts.

OVERVIEW

Introduction

Thank you for purchasing this Cloud Multi-Zone Mixer Amplifier. We are confident that you will be pleased with its performance, features, flexibility and reliability.

The Cloud 46-80 is a versatile, four-zone, rack-mounting (2U) audio mixing amplifier. It combines simple control of background music, microphone paging and power amplification for up to four zones in a single unit. It has extensive remote control facilities and is ideal for installation in premises such as pubs, bars, hotels, clubs, leisure and fitness centres, retail and other commercial premises, etc. It is compatible with Cloud PM Series paging microphones and is also designed to interface with most third-party paging microphones conforming to industry standards.

Scope of this manual

This manual provides a comprehensive guide to the features and functionality of the Cloud 46-80 Multi-Zone Mixer Amplifier.

The 46-80 is available in two versions, the 46-80 and 46-80T. The two models are identical in facilities and features, and differ only in that the 46-80T includes four factory-fitted and pre-wired CXL-80T transformers for 70/100 V-line operation. Units for the North American market (Model 46-80TNA) will be pre-wired for 70 V-line operation: units for the European (Model 46-80TEK) and Australian markets (Model 46-80TAUS) will be pre-wired for 100 V-line operation.

Please read through the manual to become fully acquainted with the various configuration and control functions the 46-80 offers. Unless stated otherwise, all information in this Installation and User Guide is applicable to both 46-80 and 46-80T variants.

The manual is arranged as follows:

- **Overview** – introduction to the 46-80 and its options.
- **Installation** – wiring the 46-80 in a practical situation.
- **Setting Up & Operation** – setting the system up and user instructions.
- **Options and Additional Information** – additional information about system options.
- **Appendix** – additional technical information. Includes technical specifications.

The 46-80 Installation and User Guide includes basic information on interfacing Cloud PM Series paging microphones and connecting Cloud RL-1/RSL-6 Series remote control plates and LM-2, BT-1, L-1 and M-1 remote input modules. Full installation information for each of these options is supplied with the items themselves.

Thank you again for placing your confidence in Cloud products.

What's in the box

Unpack the 46-80 and its accessories with care. It is always a good idea to store all packaging (if practical), in case you ever need to return the unit to your Cloud dealer for any reason.

As well as this manual, the shipping carton should contain the items listed below. Please contact your Cloud dealer immediately if any of them are missing or damaged.

- Cloud 46-80 (or 46-80T) Multi-Zone Mixer Amplifier
- IEC mains lead (AC cord) with moulded plug appropriate to the territory
- Set of mating connectors for all rear panel multi-pin screw-terminal connectors
- Set of four self-adhesive polyurethane feet

46-80 Main features

- Four zone Mixer Amplifier with flexible music and paging facilities in each zone
- 4 x 80 W power output
- Zone routing: power amplifier stages may be paralleled in various configurations and fed from a single programme source
- Peak limiter to protect power amplifier stages and loudspeakers
- Utility/Loop output with independent mic/music mix and user-definable music source
- Balanced, line level aux outputs (pre-power stage) from Zones 1 and 2, for connection of additional external amplifiers, etc.
- Front panel user controls for music source, music level and level of each microphone, for each zone
- Front panel preset controls for HF/LF EQ for each zone output: optional anti-tamper cover available
- Front panel indicators for amplifier power status, signal presence detection, Music Mute status and per-Zone signal peak
- Four balanced and two unbalanced stereo line inputs with individual gain trim controls
- Two balanced mic inputs; 15 V phantom power selectable on either or both
- Cloud Digital Paging Microphone interface – compatible with Cloud PM Series mics
- Contact closure access port for paging zone selection
- Selectable VOX-triggered mic-over-music priority
- Gain and HF/LF EQ adjustment for mic input (rear panel)
- Selectable LINE 6 priority in Zone 1 or all Zones
- Zone 1 Facility Port for connection of optional remote input modules: may also be used as additional balanced line input
- 65 Hz high-pass filter selectable per-Zone (for use with 70/100 V-line systems)
- Music Mute control input (N/O or N/C) for interface to emergency system
- Compatible with Cloud RL/RSL Series remote control panels, per-zone
- RS-232 port for serial control of per-Zone MIC 1 muting, music level and source plus global unit standby, Music Mute and MIC 2 muting
- User-selectable Automatic Power Down for maximum energy efficiency
- 2U 19" rack-mounting unit
- Convection-cooled (no fan): silent in operation
- Output protection for over-temperature, over-current and DC offset
- Universal PSU: operates from 85 V to 243 VAC, 47 to 63 Hz

Options:

- CXL-80T 70/100 V-line transformers: may be retrofitted per-channel to Model 46-80
- Front panel security cover kit: prevents access to Zone EQ controls

Optional system components

The following components may form part of the audio system and should be ordered separately if required. They can also be retrofitted to a system at a later time. Separate datasheets are available for each of the individual components; download them at www.cloud.co.uk.

LM-2 remote active module

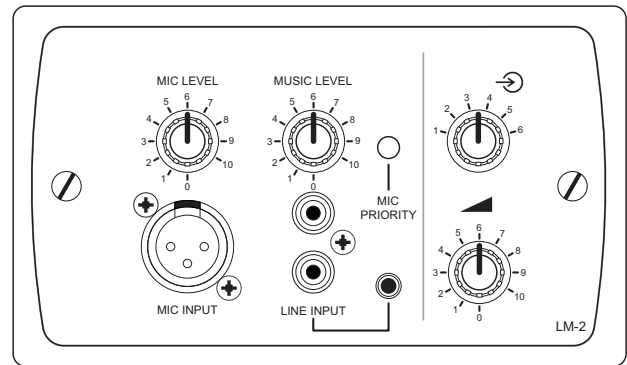

The LM-2 is an active input module with one microphone and one stereo line input, which allows a microphone and a line level audio source - such as a DJ mixer, laptop, MP3 player or similar - to be connected to the 46-80 at a remote location. The module also includes the functions of the RSL-6 Remote Control Plate (see page 9), permitting control of zone music level and source. A music ducking button activates the 46-80's priority circuitry; when enabled, a microphone signal from the LM-2 will reduce the music level in the zone. The LM-2 connects to the 46-80's **FACILITY PORT**, and thus will generally be installed within Zone 1.

BT-1 Bluetooth wireless audio module

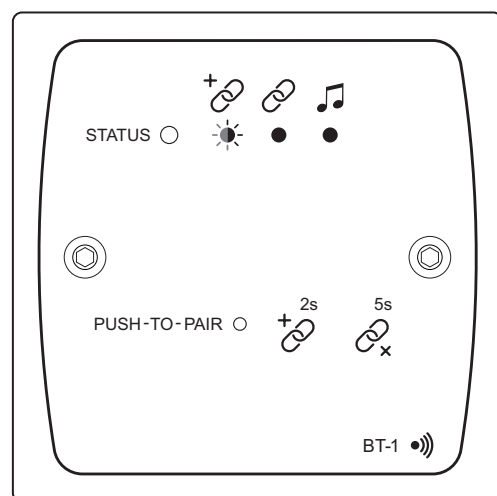

The BT-1 is a Bluetooth remote audio input module which enables compatible portable devices such as laptops, tablets

and smartphones to stream audio wirelessly to the module, and thus into the audio system of the area where the module is installed. The 46-80's priority circuitry is automatically triggered when streamed audio is detected, reducing the music level in the zone. The BT-1 connects to the 46-80's FACILITY PORT, and thus will generally be installed within Zone 1.

M-1 Series Remote Mic Input module

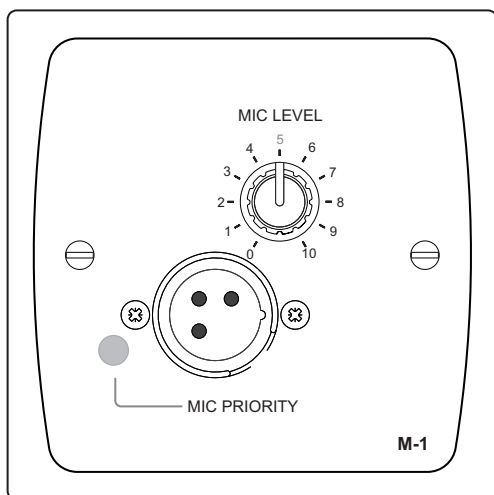

The M-1 is a remote active input module which allows a microphone to be connected within a zone and then routed to the zone's audio system. The module includes a mic level control and a switchable mic-over-music priority function. The M-1 connects to the 46-80's FACILITY PORT, and thus will generally be installed within Zone 1.

L-1 Series Remote Line Input module

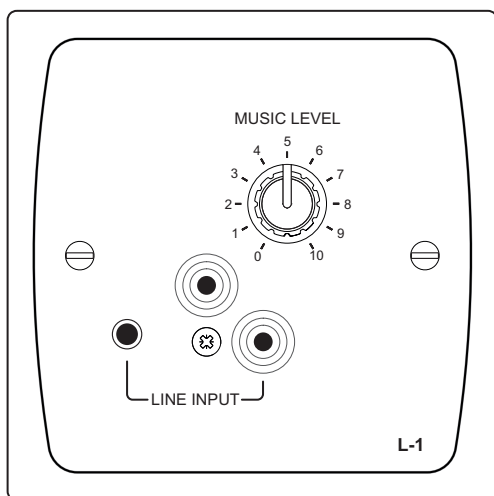

The L-1 is an active remote input module which allows a stereo line level audio source to be connected within a zone and then routed to the zone's audio system. Both phono

sockets (RCA jacks) and a 3.5 mm 3-pole jack socket are fitted, together with a music level control. The L-1 connects to the 46-80's FACILITY PORT, and thus will generally be installed within Zone 1.

RL-1 Series Remote Music Level Controls

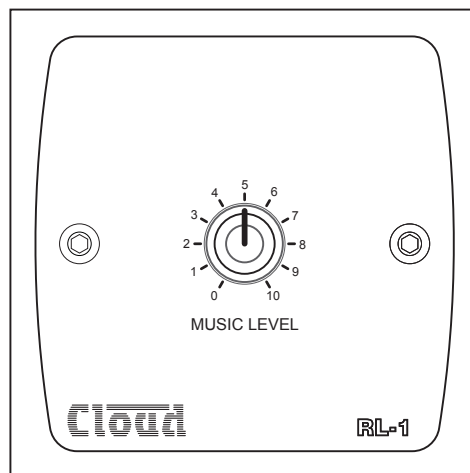

The RL-1 Series is a range of small plates with a single control for locally adjusting the music level in a zone. They connect to one of the 46-80's REMOTE MUSIC CONTROL ports.

RSL-6 Series Remote Music Level/Source Controls

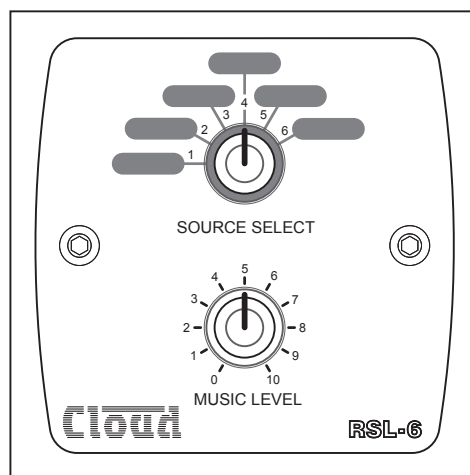

The RSL Series is a range of plates allowing local (per-zone) music source selection as well as music level control. They are the same size as the RL-1s, and connect in a similar way. The RSL-6, which provides 6-way source selection, is the appropriate version for use with the 46-80.

PM Series microphones

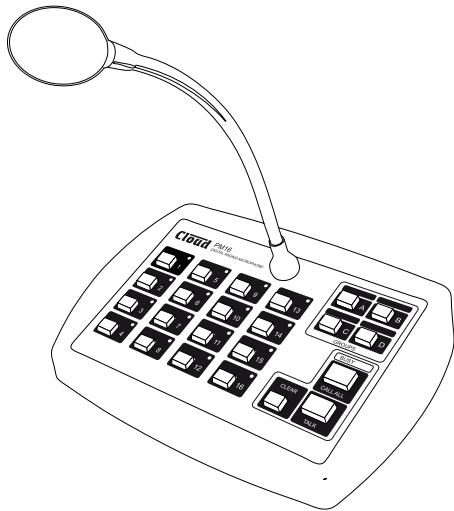

Cloud PM Series paging microphones may be connected directly to the 46-80 using the **DIGITAL PAGE MIC** port using Cat 5 cable. PM models are available for paging to 4, 8, 12 or 16 zones, and also to 4 or 8 zones with storage for built-in spot announcements. As the 46-80 only supports four zones, not all zones available from the PM8, PM12 or PM16 can be accommodated by a single 46-80; the PM4 and PM4-SA (4-zone) models are most likely to be useful.

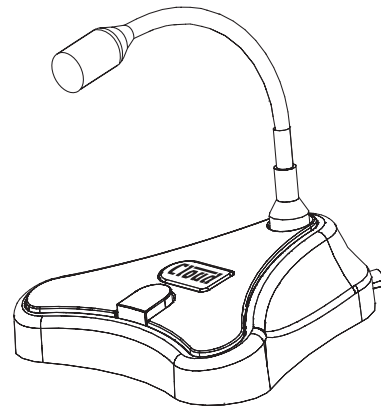

The Cloud PM1 paging microphone is also compatible with the 46-80. It is a much simpler unit which addresses a single zone (although zones may be paralleled for wider access).

Block Diagram

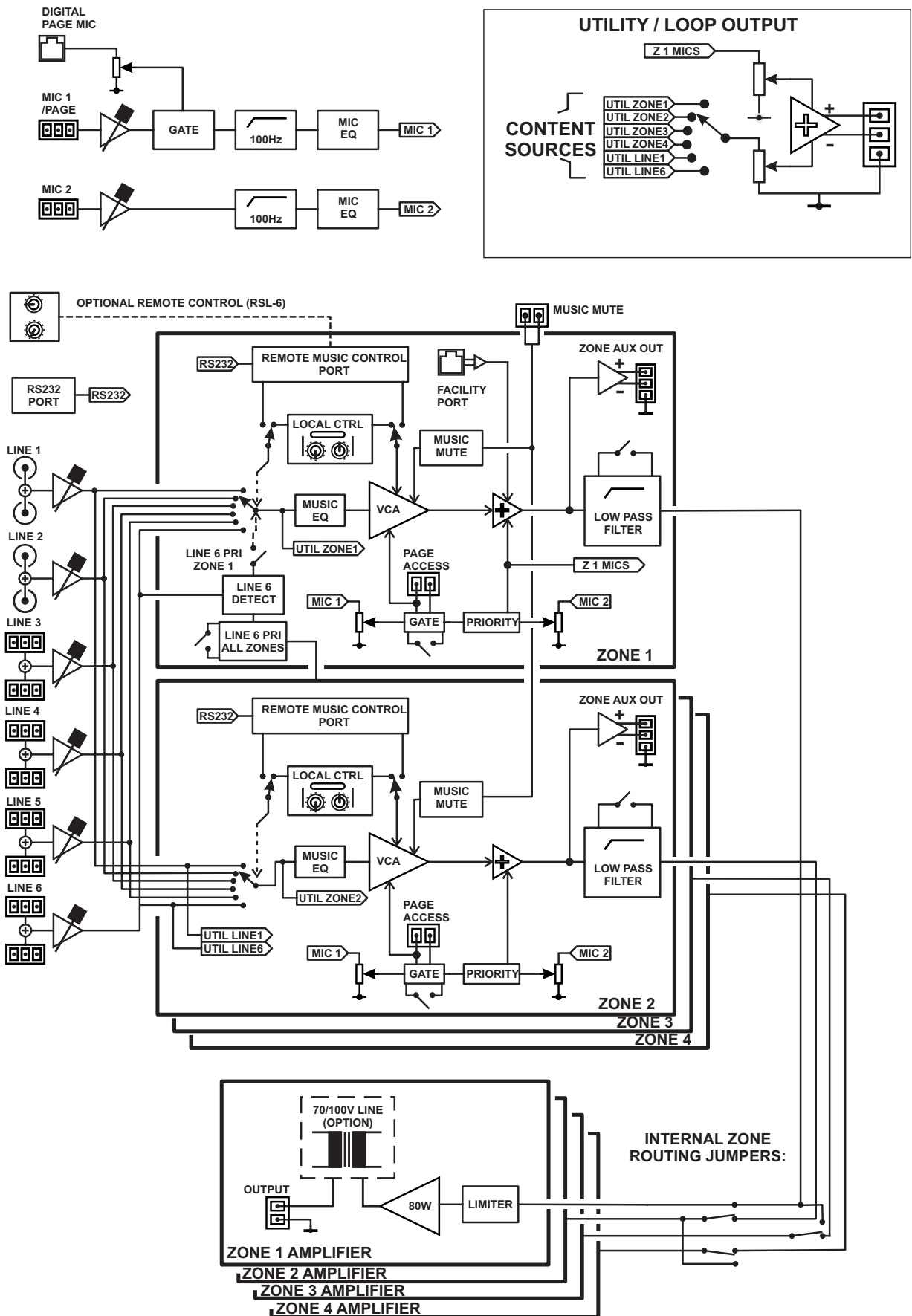

The simplified block diagram above illustrates the basic signal architecture of the 46-80.

Front panel description

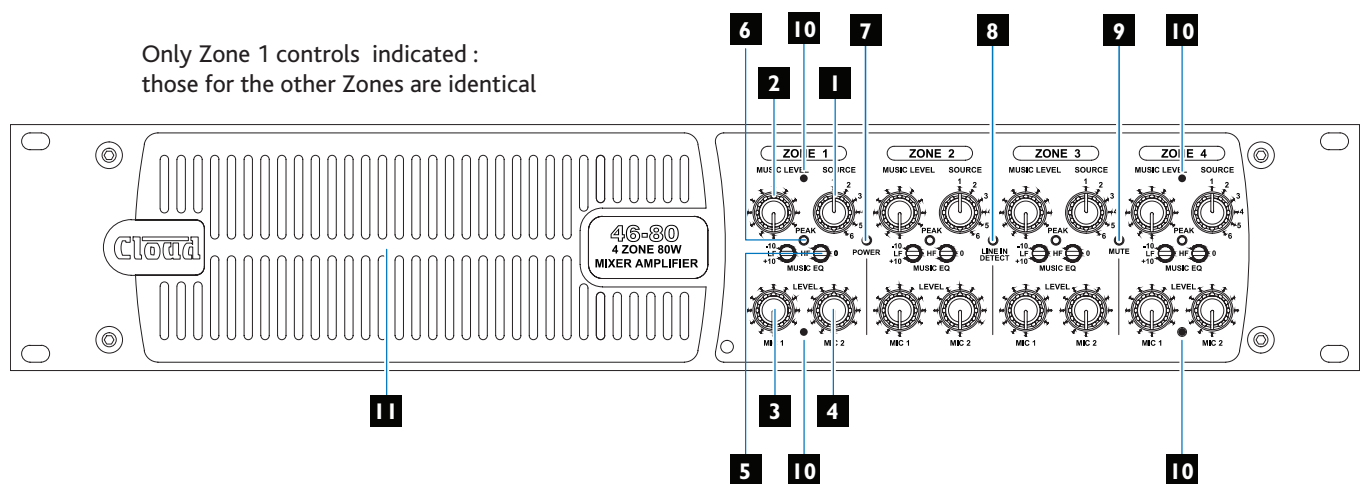

1. **SOURCE** – 6-way rotary switch selecting which Line Input (LINE 1 to LINE 6) will be the music source for each zone.
2. **MUSIC LEVEL** – adjusts the music level in each zone.
3. **MIC 1** – adjusts the level of the microphone connected to the rear panel **MICROPHONE 1/PAGE MIC** input in each zone.
4. **MIC 2** – as [3], but controls level of **MICROPHONE 2** input.
5. **MUSIC EQ** – two preset controls for adjusting HF/LF EQ in each zone:
 - LF: +/-10 dB @ 50 Hz
 - HF: +/-10 dB @ 10 kHz.
6. **PEAK** – per-zone red LEDs; illuminate if the output stage's limiter detects clipping, indicating that the level is too high.
7. **POWER** – bi-colour LED indicating power status:
 - steady green – active
 - steady red – sleep (APD) mode
 - flashing red – fault condition (over-temperature, DC protection, speaker wiring error or over-current); power-cycle to clear
8. **LINE IN DETECT** – green LED; illuminates when an input signal is detected at any of the Line Inputs.
9. **MUTE** – red LED; illuminates when the **MUSIC MUTE** function is active.
10. Fixing holes for security cover – prevents access to Zone EQ controls.
11. Ventilation slots – do not block.

Rear panel description

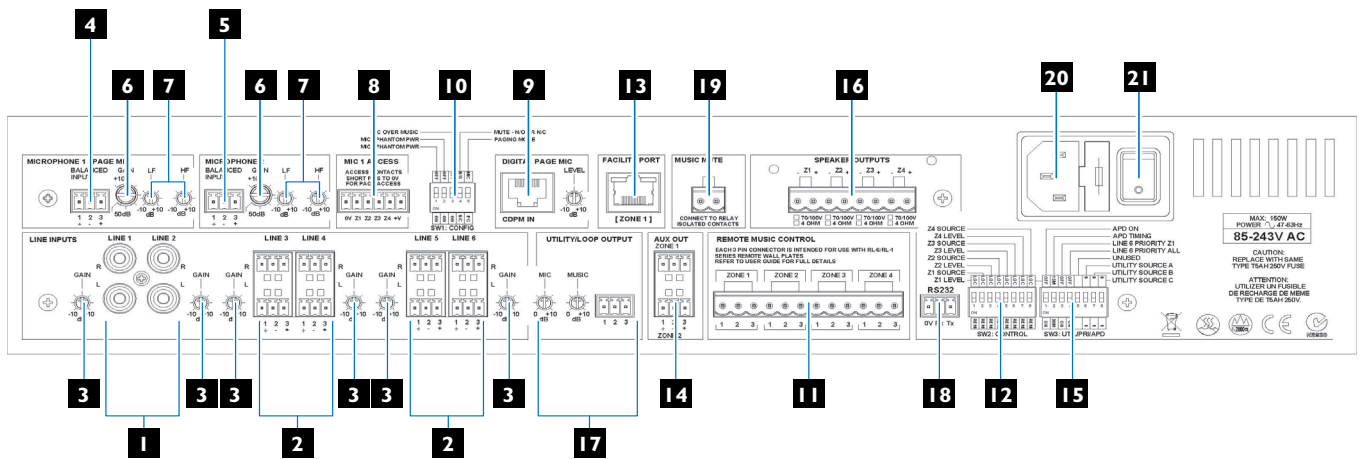

1. **LINE 1 and LINE 2** – unbalanced line inputs for connection of music sources. Two pairs of RCA (phono) sockets; inputs are stereo and summed internally to mono.
2. **LINE 3 to LINE 6** – balanced line inputs for connection of music sources. Four 3-pin, 3.5 mm-pitch screw-terminal connectors; inputs are stereo and summed internally to mono.
3. **GAIN** – preset trim control for each line input, providing +/-10 dB of gain adjustment for input level matching.
4. **MICROPHONE 1/PAGE MIC** – balanced microphone input on 3-pin 3.5 mm-pitch screw-terminal connector. This input may be used in conjunction with the **MIC 1 ACCESS** connector [8] for paging.
5. **MICROPHONE 2** – balanced input for a second microphone; 3-pin 3.5 mm-pitch screw-terminal connector.
6. **GAIN** – preset mic gain trim controls for each mic input, gain range 10 to 48 dB.
7. **MIC EQ** – two preset EQ controls for each mic input:
 - LF: +/-10 dB @ 100 Hz
 - HF: +/-10 dB @ 5 kHz
8. **MIC 1 ACCESS** – 6-pin, 3.5 mm-pitch screw-terminal connector for paging zone selection by contact closure.
9. **DIGITAL PAGE MIC** - RJ45 Cloud Digital Paging interface; PM Series* microphones (excluding the PM1) may be connected here, using Cat 5 cable.
10. **SW1: CONFIG** – 5-pole DIP switch for setting various unit configurations:

SWITCH	FUNCTION	PURPOSE
1	MIC 1 PHANTOM PWR	Enables 15 V phantom power for Mic 1
2	MIC 2 PHANTOM PWR	Enables 15 V phantom power for Mic 2
3	MIC OVER MUSIC	Enables mic-over-music priority
4	MUTE – N/O OR N/C	Configures MUSIC MUTE input
5	PAGING MODE	Configures Mic 1 Input for paging

11. **REMOTE MUSIC CONTROL** – 3-pin 5 mm-pitch screw terminal connector for each zone, for connection of RL-1/RSL-6 remote control plates.
12. **SW2: CONTROL** – 8-pole DIP switch determining whether front panel music source and/or level controls will remain active when remote control plates are connected (per-zone).
13. **FACILITY PORT [ZONE 1]** – RJ45 socket, for connection of optional remote input/control modules; may also be used as an auxiliary input.

* The earlier Cloud CDPM range of Paging Microphones is also compatible with this interface.

- 14. **AUX OUT** – line level outputs for Zone 1 and Zone 2. Outputs are balanced at 0 dBu, and are derived prior to the power amplifier stages.
- 15. **SW3: UTIL/PRI/APD** – 8-pole DIP switch for setting further unit configurations:

SWITCH	FUNCTION	PURPOSE
1	APD ON	Enables automatic standby mode
2	APD TIMING	Sets delay before entering APD mode
3	LINE 6: PRIORITY Z1	Enables Line 6 priority for Zone 1 only
4	LINE 6: PRIORITY ALL	Enables Line 6 Priority for all Zones
5	UNUSED	
6	UTILITY SOURCE A	Select source for UTILITY/LOOP OUTPUT
7	UTILITY SOURCE B	
8	UTILITY SOURCE C	

- 16. **SPEAKER OUTPUTS** – amplifier outputs for each of the four zones, on 2-pin 5 mm-pitch screw-terminal connectors per-zone. Outputs will be low impedance (4 ohms) on Model 46-80, and either 70 V-line or 100 V-line (territory-dependent) on Model 46-80T or on Model 46-80 if CXL-80T transformers have been retrofitted.
- 17. **UTILITY/LOOP OUTPUT** - an auxiliary output carrying a mix of music and mic inputs, whose music source can be set by DIP SWITCH SW3 [15]. The output is balanced, and at line level (0 dBu). The output has two associated preset level controls, **MIC** and **MUSIC**.
- 18. **RS232** - a 3-pin 3.5 mm-pitch screw-terminal connector providing a bi-directional RS-232 interface. This accepts commands to select or adjust various 46-80 functions and parameters from an external AV control system.
- 19. **MUSIC MUTE** – 2-pin 5 mm-pitch screw terminal connector for connection of external emergency muting relay (e.g., fire control panel).
- 20. **Mains** – IEC receptacle for AC mains. The receptacle has an integral fuseholder. The 46-80 will operate on all AC supply voltages from 85 to 243 V, 47 to 63 Hz.
- 21. **Power switch**.

INSTALLATION

Hardware considerations

The 46-80 Mixer Amplifier is built in a 2U-high 19" rack mount enclosure. It is recommended that it is installed in a 19" rack wherever possible. The units are approx. 320 mm deep, but at least 400 mm of rack depth should be available to allow for rear connectors and cabling.

The choice of installation location will be dictated by the specifics of the system and building layout. It is recommended that wherever possible, the 46-80 should be mounted adjacent to as many of the music sources (CD players, music servers, TV receiver boxes, etc.) as practical.

When deciding the Mixer Amplifier's location, bear in mind that access to it (particularly the rear panel) will probably be required even if a full complement of remote controls is being fitted as part of the system, as certain adjustments can only be made on the unit itself

Ventilation

The 46-80 is convection-cooled: the absence of fans makes it silent in operation. There are ventilation slots in the front and rear panels, the top and bottom panel and the right-hand side panel: ensure that these are kept unobstructed by cabling or any other items.

The 46-80 has been designed to operate in an ambient temperature range of 0°C to 35°C. While satisfactory operation outside of this recommended temperature range may be achievable in a particular installation, no guarantee can be given regarding full adherence to the performance specifications (see the Appendix section of this manual). Installers should always endeavour to fit the 46-80 in a location where the recommended temperature range is not exceeded. To help achieve this, we recommend that the 46-80 is not rack-mounted immediately above other equipment which generates heat (e.g., older designs of power amplifier).

If the unit is to be used free-standing (i.e., not mounted in a rack), the four self-adhesive feet supplied in the accessory pack should be fitted to the bottom of the enclosure.

Power Supply

The 46-80 has an internal power supply of the "universal" type, and will operate on all AC mains supplies of between 85 V and 243 V, 47 to 63 Hz. An IEC mains cable with a plug appropriate for each country is supplied with the unit. The 46-80 is very energy-efficient and only consumes 20 W in Idle mode; see the Technical Specifications at page 34 for more details.

Fuses and ratings

The only externally-accessible fuse is an AC mains fuse on the rear panel. **Only replace a fuse with one of exactly the same type.** The table below gives the correct fuse type:

Fuse Type	Fuse size	Rating
T5AH 250V	20 mm x 5 mm	5 A

If a replacement fuse blows immediately, it indicates that

the mixer amplifier has developed a fault, which should be referred to competent service personnel.

Internally, a 20mm x 5mm fast-blow 5A fuse protects each two-channel amplifier module. These are service components, and should not require attention. Failure of these fuses indicates a fault condition, which should be immediately referred to a competent technician or authorised service centre.

System connections

Music sources

Connect the system's various music sources to inputs **LINE 1** to **LINE 6**. Line Inputs 1 and 2 are unbalanced, on standard RCA jacks (phono sockets), while Line Inputs 3 to 6 are balanced, on 3-pin 3.5 mm-pitch screw-terminal connectors. All six inputs are stereo, with separate L and R connectors. The sensitivity range available should allow most standard items of audio equipment such as computers/tablets, music servers and media receivers, etc., to operate at a satisfactory level.

Balanced and unbalanced sources:

Source equipment with stereo unbalanced outputs may be connected directly to Line Inputs 1 or 2, and as long as the source is adjacent to the Zone Mixer, normal phono-phono (or 3.5 mm jack-to-phono leads) can be used. Always avoid using pre-made leads of an unnecessary length.

Source equipment with stereo balanced outputs should be connected to Line Inputs 3 to 6, using twin-and-screen cable and the pinout below:

PIN	CONNECTION
1	Screen
2	Signal '-' (cold)
3	Signal '+' (hot)

If it is necessary to connect an item of source equipment with a balanced output to Line Inputs 1 or 2, the ideal method is to use a balancing transformer between the source and the unbalanced input. Suitable audio transformers, which should have a ratio of 1:1, are readily available from major audio component suppliers. The transformer(s) should be mounted as close to the Zone Mixer as practical, and housed in a screened enclosure if they are not individually screened. The preferred connection method is shown below:

Balanced outputs (XLRs):

pin 1 ground
pin 2 hot
pin 3 cold

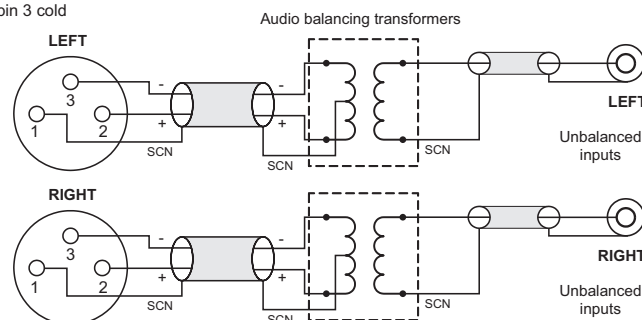

Mono and stereo sources:

The mixing section of the 46-80 is mono; the stereo line inputs are summed internally. Stereo sources should be connected in a normal stereo configuration, using both L and R inputs. If connecting a mono source with only a single output, it may be connected to either the left or the right input.

Microphone inputs

Inputs **MICROPHONE 1/PAGE MIC** and **MICROPHONE 2** are intended for the direct connection of microphones. They are electronically balanced and transformerless with an input impedance of greater than 2 kohms and optimised for use with microphones of 200 to 600 ohms impedance. The screw terminal input connectors should be wired thus:

PIN	CONNECTION
1	Screen
2	Signal '-' (cold)
3	Signal '+' (hot)

Unbalanced microphones may be used by connecting pin 2 to pin 1 (cable screen) in the mating (male) screw-terminal connector. 15 V phantom power is available, see page 22.

Either mic input may be routed to any of the zones in use, at any level in each zone. Microphone priority may be set so that any microphone announcements automatically reduce the music level in that zone while the announcement is in progress (see page 23 for more details.)

Paging system connections

Cloud PM Series paging microphones may be connected directly to the 46-80. All models except the PM1 can use either the Cloud Digital Paging Interface or an industry-standard analogue interface; Model PM1 uses the analogue interface.

PM microphones are available in 4, 8, 12 or 16-zone versions; the PM-4 (or PM-4SA) is the appropriate model for use with the four-zone 46-80.

Whichever connection method is employed, in order for **MICROPHONE 1/PAGE MIC 1** to function correctly with a paging mic, rear panel DIP switch SW1/5 (**PAGING MODE**) should be set to PG (switch down). For automatic music ducking during an announcement, DIP switch SW1/3 (**MIC OVER MUSIC**) should be set to ON (switch down). See page 23 for further information.

Connecting a PM4/4SA paging mic via the Cloud Digital Paging Interface

The 46-80 is fitted with a Cloud Digital Paging Interface; this uses a RJ45 socket and is indicated as the **DIGITAL PAGE MIC** connector on the rear panel ([9] at page 13). Cloud PM Series Paging microphones may be connected directly with Cat 5 cable; the single connection provides all audio, control and power required by the microphone.

The port is able to supply 250 mA to power paging microphones. This is adequate to power one or two PM-4 microphones. Cloud recommend that all '-SA' models (with spot announcement sound stores) are powered by a separate, external PSU, as described in the PM Series Installation Guide. (A suitable PSU is supplied as standard with all '-SA' models.)

Connect the **OUT** socket of the PM Series microphone to the **DIGITAL PAGE MIC** socket on the Zone Mixer with Cat 5 cable. Use the standard Cat5/RJ45 wiring convention as shown below (note that some makes of cable may have a white trace added to the cores with a 'single' colour):

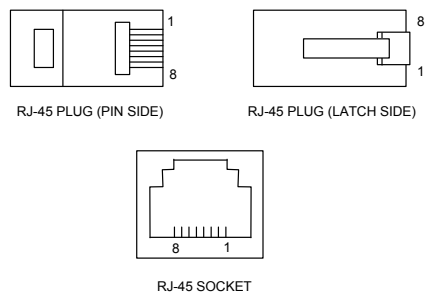

RJ45 PIN	CAT5
1	White + Orange
2	Orange
3	White + Green
4	Blue
5	White + Blue
6	Green
7	White + Brown
8	Brown

The Cloud Digital Paging Interface allows multiple PM Series microphones to be "daisy-chained". If more than one paging microphone is being installed – typically at different locations in the building, connect the **OUT** socket of one to the **IN** socket of the next.

IMPORTANT - Please refer to the PM Series Installation Guide for full information regarding maximum cable length, buss terminations and current requirements.

The earlier Cloud CDPM Series of paging microphones is also compatible with the Digital Paging Interface.

Connecting a PM4/4SA paging mic via the analogue interface

Two connections are required: the paging mic audio signal should be connected to the **MICROPHONE 1/PAGE MIC Input** ([4] on page 13) and the control cable to the **6-pin MIC 1 ACCESS** port ([8] on page 13). The pinout of the port is given below:

PIN	FUNCTION
1	0 V
2	Zone 1
3	Zone 2
4	Zone 3
5	Zone 4
6	+Vsupply

Standard two-core screened audio cable may be used for the audio signal, and stranded six-core cable with an overall screen for the control cable. (Note that '-SA' versions of PM Series microphones cannot be powered by the 46-80, and require an external PSU.)

Connections on the PM microphone are made via the rear cable access glands and screw terminal blocks on the internal PCB (**TERM1**, **TERM4** and **TERM8** in the example shown below). Full connection details and notes on power supply considerations can be found in the PM Series Installation and User Guide.

The diagram below shows both cable connections between a PM4 and a 46-80. Note that the DC power supply connection will not be required if the PM microphone is powered independently (either by a local PSU or via the network from another PM unit).

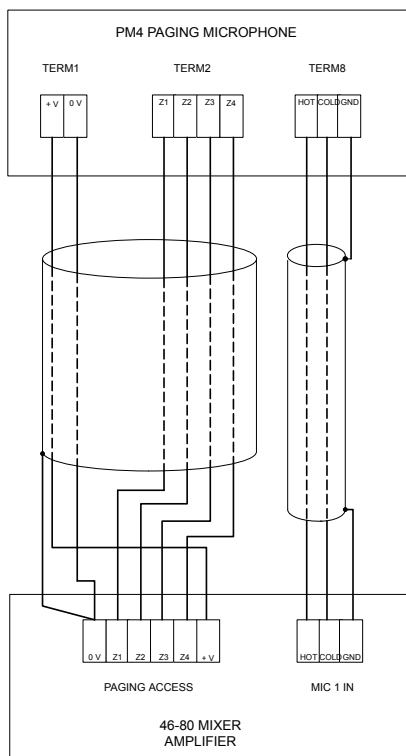

Connecting a PM1 paging mic

The PM1 is a simple, passive paging microphone suitable for situations where announcements are always made to the same zone(s). It can be connected directly to the 46-80's analogue paging interface, the control cable being wired to the pin(s) of the MIC 1 ACCESS port corresponding to the zone(s) in which announcements are required. Any or all of the zones may be paralleled if multiple zones need to operate from the PM1.

Either a single 2-pair individually-screened cable may be used (this gives the neatest finish), or two separate standard microphone cables. Note that the PM1 does not require DC power. Connections on the PM1 are made via the rear cable gland in the base and the screw terminal blocks on the internal PCB (**U2** and **U3**). Full connection details can be found in the PM1 Installation and User Guide.

The diagram below shows the connections between a PM1 and a 46-80. Use of 2-pair cable is assumed; the same wiring principle is adopted if separate cables are being used for audio and control.

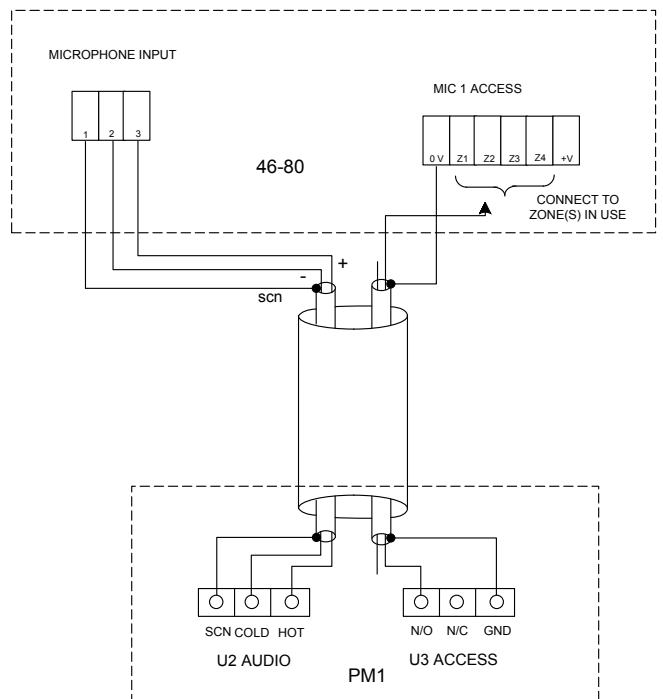

Remote music control

Like most other Cloud host units, the 46-80 allows remote control of music level and source selection in each of the primary zones (i.e., excluding the Utility/Loop output). Cloud remote control plates from the RL-1 Series (music level only) and RSL-6 Series (music level and source selection) provide an elegant solution, though control via a DC voltage from third-party systems is also possible (see page 28).

Both types of plate connect via the **REMOTE MUSIC CONTROL** connectors for the relevant zone (see [11] on page 13). These connectors are 3-pin 5 mm-pitch screw terminal type.

Connecting an RL-1 Series remote control plate

Wire the remote control plate as shown below using screened cable as shown. Maximum reliable cable run is 100 m.

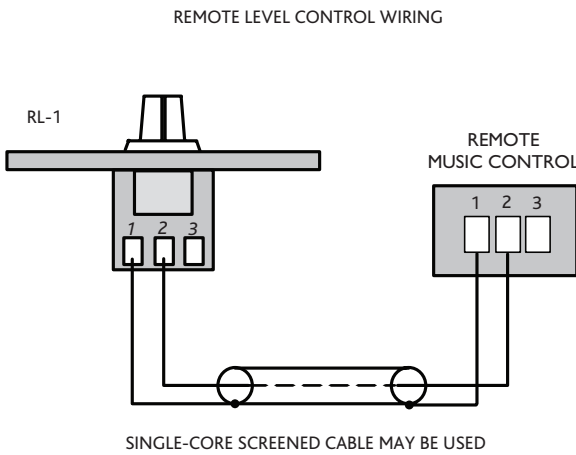

Before the RL-1 will operate, the zone's Remote Music Control port must be enabled by setting the appropriate section of rear panel DIP switch SW2 ([12] on page 13) to REM (switch down). The odd-numbered sections of SW2 are used to enable remote level control, as shown in the adjacent diagram. When set to REM, the zone's front panel **MUSIC LEVEL** control becomes inoperative. Music source selection will still be available from the mixer amplifier's front panel when an RL-1 is in use.

Connecting an RSL-6 Series remote control plate

Wire the remote control plate as shown below. Twin-and-screen cable should be used. Maximum reliable cable run is 100 m.

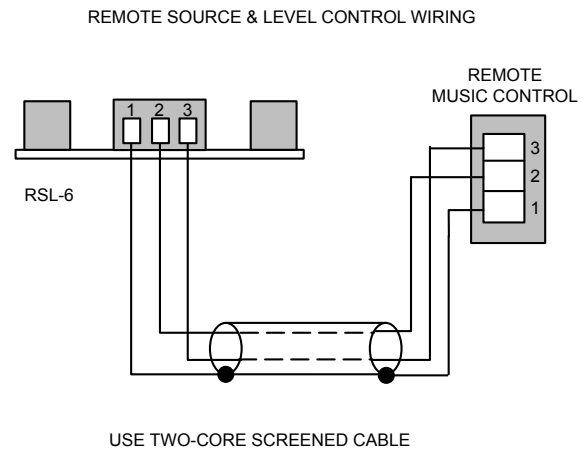

Before the RSL-6 will operate, the zone's Remote Music Control Port must be enabled by setting the appropriate two sections of rear panel DIP switch SW2 ([12] on page 13) to REM (switches down). Note that separate switch sections independently enable the music level and music source selection for each zone: for an RSL-6 to work fully, both sections must be set to REM. With this setting, the zone's front panel **MUSIC LEVEL** and **SOURCE** controls will be inoperative. The user may wish to limit the functionality of an RSL-6 to only music source selection (i.e., no remote control of volume), in this case only the even-numbered switch sections should be set to REM.

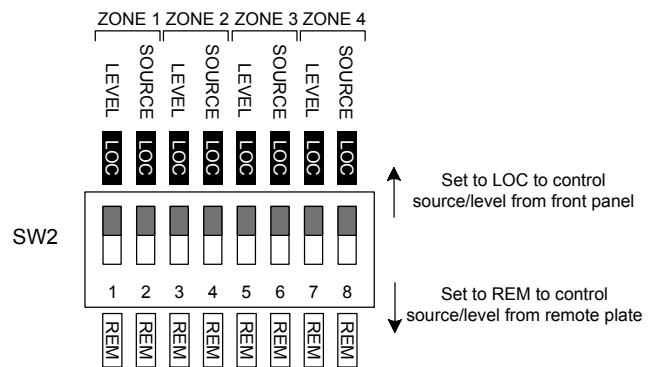

Zone 1 Facility Port

Zone 1 of the 46-80 is provided with a **FACILITY PORT** in the form of an RJ45 connector on the rear panel ([13] on page 13). This may be used to connect a Cloud remote active input/control module, but may also be used as a general-purpose auxiliary balanced input (see Page 29 for more information on this application). Note that an audio source connected via the **FACILITY PORT** will only be available in Zone 1, and no other.

Active modules operate from DC power supplied by the 46-80. The current consumed by each module is minimal and in the vast majority of installations there will be no power supply issues.

The pinout of the **FACILITY PORT** connector is given in the table below (note the first colour of a core is the primary colour, the second the trace colour):

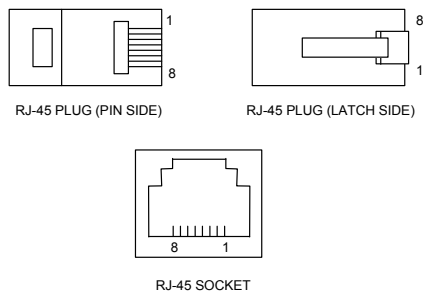

PIN	USE	Cat 5 CORE*
1	Audio 'cold' phase (-)	White + Orange
2	Audio 'hot' phase (+)	Orange
3	Priority VCA control	White + Green
4	+ 15 V	Blue
5	0 V	White + Blue
6	-15 V	Green
7	Music level control (0 to 10 V)	White + Brown
8	Music source select control (0 to 10 V)	Brown
SCN	Screen for system music controls	Connector shell

* Standard wiring for pre-made cables. Note that some makes of cable may have a white trace added to the cores with 'single' colours.

Connecting an active remote module

The following Cloud active remote input modules are directly compatible with the 46-80 and may be connected to the **FACILITY PORT** using screened Cat 5 cable:

- LM-2 combined mic/line input and music source/level control module
- BT-1 Bluetooth wireless input module
- L-1 stereo line input module
- M-1 balanced mic input module with priority control

Note that as the cable carries analogue audio, *only* screened Cat 5 should be used. All the remote modules listed above use RJ-45 connectors as their interface: ready-made screened Cat 5 cables may be used if suitable lengths are available. Otherwise, install bulk screened Cat 5 cable and fit crimpable screened RJ45 connectors, using the standard wiring convention in the pinout table above.

NOTE: The LM-2 has a **LINK** connector as well as an **OUTPUT**: this allows multiple LM-2s to be "daisy-chained". If more than one LM-2 is being installed – typically at different locations in the same zone, connect the **OUTPUT** socket of one to the **LINK** socket of the next.

Speaker outputs (Lo-Z)

The power amplifier outputs on Model 46-80 are available on an 8-pin, 5 mm-pitch screw-terminal connector **SPEAKER OUTPUTS** ([16] on page 13): first remove the safety cover protecting it (2 x M3 screws). Four mating 2-pin connectors are supplied; the outputs for all four zones are present on the connector. Connect to speakers using pairs of terminals as shown in the table:

Pin (L to R)	Panel marking	Connect to:
1	Z1 -	Zone 1 output '-'
2	Z1 +	Zone 1 output '+'
3	Z2 -	Zone 2 output '-'
4	Z2 +	Zone 2 output '+'
5	Z3 -	Zone 3 output '-'
6	Z3 +	Zone 3 output '+'
7	Z4 -	Zone 4 output '-'
8	Z4 +	Zone 4 output '+'

Each output stage is designed to drive into an impedance of not less than 4 ohms. Check the impedance of the loudspeaker(s) in use and, taking into account any series and/or parallel wiring, ensure that the total load on each channel is not less than 4 ohms.

Speaker outputs (70/100 V-line operation)

Model 46-80T has four CXL-80T transformers pre-installed and is thus ready for 70/100 V-line operation. Any or all zone outputs of Model 46-80 may be converted for 70/100 V-line operation by retrofitting CXL-80T transformers as necessary. See page 29 for details of CXL-80T transformer installation.

Note that immediately below the **SPEAKER OUTPUTS** connector the rear panel is printed with check boxes marked **4 OHMS** and **70/100V** to indicate how the output is configured for each zone. These will be marked according to model type (46-80 or 46-80T) prior to shipment.

In Model 46-80T, the factory-fitted CXL-80Ts are wired for 70 V-line operation in units for North American territories and Australia, and for 100 V-line operation in units for Europe. This can be changed if wished by moving internal connectors.



Use the same speaker wiring as shown for low-impedance operation in the table above. Ensure that the unit is disconnected from the AC mains supply when making connections to avoid any risk of electric shock

IMPORTANT - After making the connections and plugging in the mating connectors, refit the safety cover over the **SPEAKER OUTPUTS** socket. Making contacts carrying 70 V or 100 V inaccessible is likely to be a legal requirement in most territories.

When the 46-80 is configured for 100/70 V-line operation, the 65 Hz high-pass filters in each zone to be used in this mode should be enabled: this is done by moving internal jumpers. Model 46-80T has the filters pre-enabled at the factory. See page 24 for full details.

Utility/Loop output

The **UTILITY/LOOP OUTPUT** is an additional balanced line level output which is primarily intended for driving an external hearing loop amplifier, but can also be used for any other purpose. The source may be the programme in any of the four Zones or always either Line Input 1 or Line Input 6, and is selected by rear panel DIP switches. See page 24 for full details.

The output connector is a 3-pin, 3.5 mm-pitch screw terminal type ([17] on page 13), wired as follows

PIN	CONNECTION
1	Screen
2	Signal '-' (cold)
3	Signal '+' (hot)

Auxiliary line outputs

In large zones, it may be necessary to use additional amplifiers to obtain the necessary power to drive a greater number of loudspeakers, or to drive some loudspeaker types requiring higher power levels than the 80 W available from each of the 46-80's outputs. To permit the connection of further amplifiers - or any other equipment - balanced outputs from Zones 1 and 2 pre-amplifier sections are available at the rear panel **AUX OUT** connectors, [14] at page 13.

The two connectors are of 3-pin, 3.5 mm-pitch screw terminal type. Wire using the pinout in the table below:

PIN	CONNECTION
1	Screen
2	Signal '-' (cold)
3	Signal '+' (hot)

Connect to balanced inputs on external equipment with twin-and-screen cable. The auxiliary outputs may also be connected to unbalanced inputs: Cloud recommend the use of external balancing transformers to achieve this, as shown below:

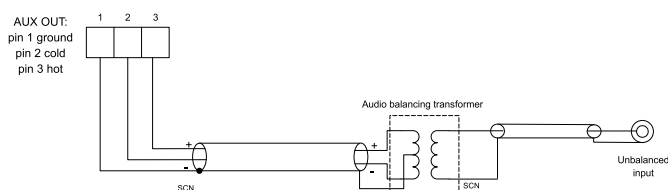

If balancing transformers are not available, satisfactory results are likely to be obtained by connecting pin 3 to the signal pin of the unbalanced input (e.g., the tip of a phono/RCA connector) and pin 1 to the connector's outer screen. Do not connect pin 2.

Note that all Zone 1 and 2 controls and settings on the front and rear panels (levels, source selection, priority settings, etc.) affect the auxiliary outputs.

Music Mute

External muting of music is available at the **MUSIC MUTE** connector. Note that Music Muting only applies to Zone Outputs 1 to 4 and the Auxiliary Outputs, and not to the **UTILITY/LOOP** output. National or Local Authority regulations governing such systems may require that normal programme material (i.e., music) should be muted in an emergency, to ensure that any emergency messages are clearly audible.

The **MUSIC MUTE** input is on a 2-pin 5 mm-pitch screw-terminal connector. It should be connected to the appropriate alarm output on whichever building management system registers the alarm (typically the Fire System). The alarm output must be volt-free; if no such output is available, an intermediate relay or other isolation device must be installed between the alarm output and the Music Mute input.

Music Muting can be triggered by either normally-open contacts, or normally-closed contacts. This selection is made by rear panel DIP switch SW1/4 (**MUTE – N/O OR N/C**): the default setting is N/O.

REMOTE MUSIC MUTE TERMINATIONS

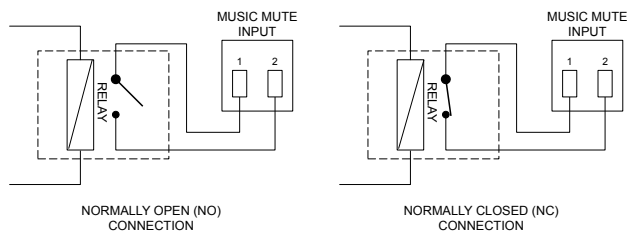

The red **MUTE** LED on the front panel ([9] on page 12) illuminates when Music Muting is active

RS232 Serial Port

The 46-80 can accept commands from third-party AV systems using standard RS232 protocol. A bidirectional serial port - marked **RS232** - is available on the rear panel ([18] on page 13). This is a 3-pin, 3.5 mm-pitch screw-terminal connector, and should be wired as below:

PIN	CONNECTION
1	0 V
2	Data Rx
3	Data Tx

Note that not all control systems interpret "Tx" and "Rx" the same way, and the installer should check whether pins 2 and 3 should be "crossed" within the cable.

See Page 26 for more details of RS232 control and an abridged command set.

SETTING UP & OPERATION

Music Inputs

Gain & level

To avoid dramatic changes in volume when switching between sources, the 46-80's music inputs are provided with preset gain trim controls ([3] on page 13). These vary the input sensitivity from -12 dBu (195 mV) to +8 dBu (2.0 V). When setting the system up, play audio from all the sources in use and listen to them one at a time in a convenient zone (ideally that in which the mixer is located) at a reasonable volume. Taking a source of "average" volume as the reference, the gain controls of the others should be adjusted so that there is no appreciable difference in volume between any of the sources. (With a typical music source, setting the gain on its channel to mid-way is a good starting point.) Note that consideration may need to be given to the type of programme in use, particularly if one or more sources are TV sound.

In normal operation, the music level in each primary zone is set with the **MUSIC LEVEL** control on the front panel ([2] on page 12). This control will not be operative if the corresponding section of rear panel DIP switch SW2 is set to REM.

Note that the setting of the music level has no effect on microphone volume.

The front panel is fitted with a green **LINE IN DETECT** LED ([8] at page 12), which illuminates if a signal is present at any of the six Line Inputs: note that the signal detection is post the rear panel **GAIN** controls. The LED's threshold level is -30 dB, with a **GAIN** control setting of 0 dB. The **LINE IN DETECT** LED is a useful aid to system troubleshooting as it confirms that a music source signal is present at the 46-80.

Each of the four Zones has a front panel **PEAK** LED ([6] at page 12), which illuminates if the signal level in the power stage approaches clip level. This will probably indicate that either the music level or the microphone level is set too high and should be reduced.

Local/remote control

If a zone has an RL-1 or RSL-6 Series remote control plate installed, the two sections of rear panel DIP switch SW2 – LEVEL and SOURCE – for the zone in question must be set to REM (switches down) for the remote controls to be operative and for the corresponding front panel controls to be disabled. Zones without such plates should be set to LOC (both switches up).

Note that unlike earlier Cloud host units, remote control of music level and music source selection can be enabled independently of each other. There are no internal jumpers affecting the remote music control configuration.

Microphone input

Phantom power

Both microphone inputs have 15 V phantom power available. This will be adequate to power a wide range of condenser microphones. (Some "studio quality" mics may require a higher phantom voltage and thus necessitate an external PSU.) To enable phantom power at a mic input, set rear panel DIP switch SW1/1 (**MIC 1**) and/or SW1/2 (**MIC 2**) should be moved to the ON position (switch down).

Phantom power should NOT be enabled if dynamic microphones are to be used.

Gain & level

Each microphone input is provided with a rear panel preset **GAIN** control ([6] on page 13). A wide range of gain is available and there should be no problem in obtaining a satisfactory level from any normal microphone.

The **GAIN** controls should be adjusted by speaking normally into a microphone of the correct type. Turn the relevant front panel **MIC LEVEL** control up to maximum and listen in a convenient zone; the rear panel gain control should be carefully advanced until the mic volume is as loud as it is ever likely to be needed, and then reduced slightly. There should be no audible distortion. The use to which the microphone is to be put should be borne in mind – karaoke is more likely to overload the mic preamplifier than spoken announcements, if the gain is not set correctly.

In normal operation, the mic level in each zone is set with the **MIC LEVEL** controls on the front panel ([3] and [4] on page 12).

Each of the four Zones has a front panel **PEAK** LED ([6] at page 12), which illuminates if the signal level in the power stage approaches clip level. This will probably indicate that either the music level or the microphone level is set too high and should be reduced.

EQ

Each mic input has associated HF and LF EQ controls ([7] on page 13) These provide 10 dB of cut or boost at 5 kHz and 100 Hz respectively and should be adjusted by listening to achieve a clear mic sound. Again, the application should be borne in mind when making adjustments.

High-pass filter

The mic input has a fixed 100 Hz high-pass filter to remove the lowest frequencies. This helps to reduce the effects of breath blasts and microphone handling noise. The filter is always in circuit.

Paging and Priority Settings

The 46-80 offers several options for determining what happens to music signals when announcements are made.

Mic-over-Music priority

Fully automatic, voice operated priority is available for the two mic inputs. This is selected by the rear panel DIP switch SW1/3 (**MIC OVER MUSIC**), which is set to OFF at the factory. In this mode, signals at the two mic inputs will be mixed with the selected music signal in all zones, with the relative levels of music and each microphone adjustable with the front panel controls. Setting SW1/3 to ON (switch down) causes all music signals to be attenuated by approximately 30 dB when a microphone is used; when microphone use finishes, the music signals will restore smoothly to their former level.

Paging mode

IMPORTANT: For the purposes of paging, the **DIGITAL PAGE MIC** port uses Mic 1's input channel. The description of Paging Mode below applies both to digital paging microphones connected to this port, or to "traditional" paging microphones connected to the **MICROPHONE 1 / PAGE MIC** input. Note that the **DIGITAL PAGE MIC** input has its own **LEVEL** control adjacent to the RJ45 connector.

Mic Input 1 can be used with Cloud PM Series Paging Microphones, or most models from other manufacturers. To configure the input for paging, set rear panel DIP switch SW1/5 (**PAGING MODE**) to PG (switch down). In this mode, the signal at Mic 1 input will not be routed to the outputs unless i) a destination Zone is defined, either by connecting one or more of the zone access pins of the **MIC 1 ACCESS** connector to 0 V or by selecting a destination Zone on a Digital Paging Microphone connected to the **DIGITAL PAGE MIC** port, and ii) a signal being detected at the Mic 1 input, i.e., by an announcement commencing.

Paging will generally require music to be ducked, so when configuring the 46-80 for paging use, set SW1/3 (**MIC OVER MUSIC**) to ON as described above. With these settings, the 46-80's VOX circuitry will detect an announcement and trigger mic-over-music priority. Note that if there are long gaps in the announcement, the priority release may allow the music to fade up in the gaps.

Line 6 priority

It may sometimes be necessary for one music input to have priority over all the others; for example, a jukebox in a bar, a digital sound store programmed to make automatic announcements in a public space, or for emergency announcements from an external system. Input **LINE 6** may be set to have priority either in Zone 1 only, or in all six Zones, over whichever source is selected for the zone(s) by the **SOURCE** control(s). This priority is set by rear panel DIP

switch SW3/3 (**LINE 6 PRIORITY Z1**) to ON for Zone 1 only, or by SW3/4 (**LINE 6 PRIORITY ALL**) to ON for all Zones. (The default setting for both is OFF.)

When the priority is selected, a signal present at Line 6 will force the music source selection in either Zone 1 or every Zone (depending which Line 6 Priority option is selected) to that input; when the signal disappears, the previously-selected source will be smoothly restored.

Mic-over-Facility Port priority

If a remote active module is in use in Zone 1, it is possible to give a microphone connected at the 46-80 itself (at **MICROPHONE 1/PAGE MIC**, **MICROPHONE 2** or the **DIGITAL PAGE MIC** port) priority over input sources connected at the module. This might be desirable in function rooms, for example, where building-wide announcements may need to interrupt any local use.

Mic-over-music priority must first be enabled by setting rear panel DIP switch SW1/3 (**MIC OVER MUSIC**) to ON (switch down). Mic-over-Facility Port priority is then set by internal main PCB jumper J2. The default setting is OFF; in this position microphones or other sources connected at remote input modules will be autonomous and will not be overridden by announcements made via the mixer's mic inputs. Setting J2 to ON will give priority to Mic 1 or Mic 2. The release time following an announcement is approx. 0.5 s.

Note that this priority is independent of the local **MIC PRIORITY** function which is selectable on an LM-2 remote module.

Zone outputs

In normal operation, the music level in each zone will be set by the front panel **MUSIC LEVEL** control ([2] at page 12), or by the corresponding control on a remote plate.

EQ

The various zones in a building often have different acoustic properties, and may also have different models of loudspeaker installed. The 46-80 is fitted with per-zone HF and LF EQ adjustments for the music signal ([5] on page 12) to enable the audio frequency response to be best matched to each zone's acoustics. The controls should be adjusted by listening; up to 10 dB of cut or boost at 10 kHz (HF) and 50 Hz (LF) is available. Note that these EQ adjustments do not affect the frequency response of the microphone signal.

After the EQ has been adjusted during system commissioning, the EQ presets may be made inaccessible by fitting a security cover, Part No. CA379056, available as an option from Cloud Electronics.

High-pass filters

When an amplifier is used to drive 70/100 V-line loudspeaker systems, there is a risk of transformer saturation at high levels and low frequencies. To prevent this, each of the 46-80's four channels is provided with a switchable 65 Hz high-pass filter. This should be enabled for any channel being used to drive 70/100 V-line systems. On Model 46-80T, the filters will be factory-enabled for all channels: on Model 46-80, they will be disabled for all channels. If a Model 46-80 is to be used to drive 70/100 V-line speaker systems, either by retrofitting one or more CXL-80T transformers, or by the use of external transformers, they should be enabled.

The filters are enabled by moving internal PCB jumpers J3 (Zone 1), J4 (Zone 2), J5 (Zone 3) and J6 (Zone 4). See page 30 for locations of PCB jumpers.

Zone Routing (using output stages in parallel)

In some installations, a higher power output may be required in a zone than the 80 W the 46-80's power stages are rated at. To meet this requirement, the power stages may have their inputs reconfigured so that two or more may be fed by a single pre-amplifier stage. For example, the power stages for Zones 1 and 2 may be both fed by Zone 1's pre-amplifier stage: in this case, the front panel Zone 1 controls will affect both Zone Speaker Outputs, and the Zone 2 controls will be non-operational. (Clearly, using this option reduces the overall number of zone outputs available.)

The alternative Zone routings are selected by moving internal PCB jumpers J7, J8 and J9 in various combinations. See page 30 for locations of PCB jumpers. The diagram below summarises the jumpers' effects:

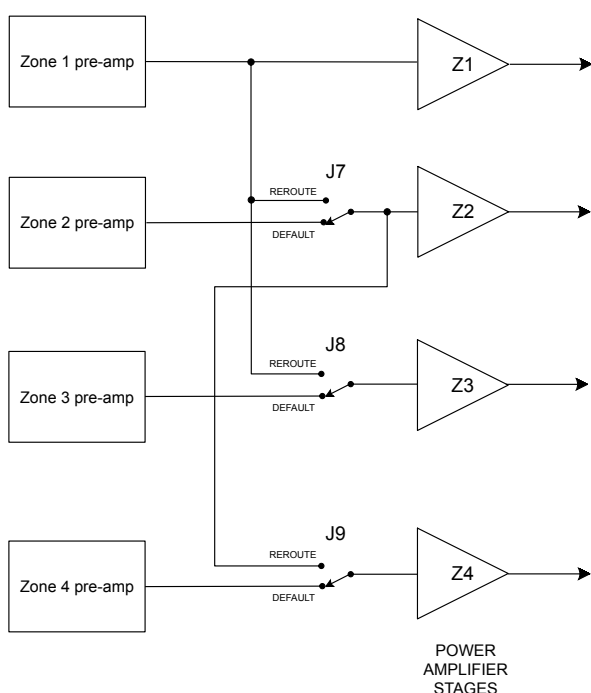

The table below shows all the routing configurations available from the eight possible combinations of jumper settings:

	JUMPER			AMP CHANNEL				
	J7	J8	J9	CH1	CH2	CH3	CH4	
R=REROUTED = DEFAULT	D	D	D	Z1	Z2	Z3	Z4	INPUT ZONE
	R	D	D	Z1	Z1	Z3	Z4	
	D	R	D	Z1	Z2	Z1	Z4	
	R	R	D	Z1	Z1	Z1	Z4	
	D	D	R	Z1	Z2	Z3	Z2	
	R	D	R	Z1	Z1	Z3	Z1	
	D	R	R	Z1	Z2	Z1	Z2	
	R	R	R	Z1	Z1	Z1	Z1	

The diagram below illustrates some useful configurations with the necessary jumper settings:

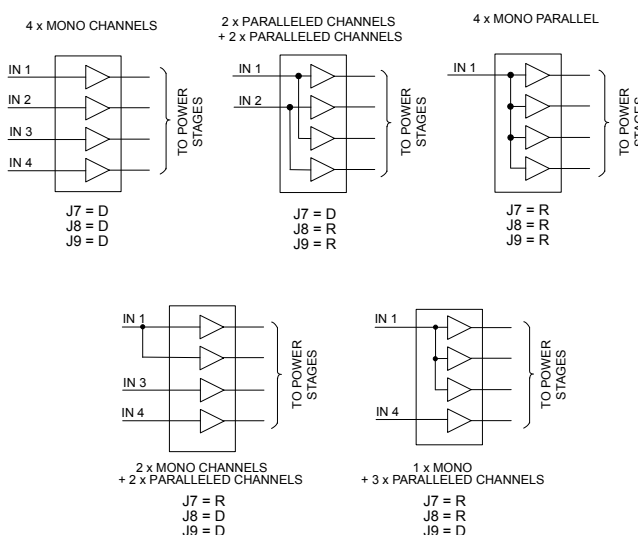

Utility/Loop Output

The UTILITY/LOOP OUTPUT ([17] on page 13) is primarily intended to drive an external hearing loop amplifier, though as a balanced line level output, it may be used for any purpose required by the audio system.

Eight source options are available for the music component of the signal at the Utility/Loop output, and is selected by rear panel DIP switches SW3/6, SW3/7 and SW3/8 (UTILITY SOURCE A, B and C respectively). The options are:

- The Utility/Loop output always follows the music source selection made for any of the four Zones (either on the front panel or via remote control). The **MUSIC LEVEL** control for the selected Zone does not affect the level at the Utility/Loop output. If Line 6 Priority is enabled for the selected Zone, its effect will also be heard via the Utility/Loop output, ensuring that e.g., emergency messages will always be heard via the hearing loop. However, music will not be ducked by Mic-over-Music priority, if it is enabled.
- The Utility/Loop output always follows the source connected to **LINE IN 1**.

- The Utility/Loop output always follows the source connected to **LINE IN 6**: this option is useful if Line 6 Priority is enabled for emergency messages, but there are building areas which need not be fed with music. The output will only carry the Line In 6 source when it is active.

Selection of music source is made by the following table; 0 = switch up, 1 = switch down:

SW3	UTILITY A	UTILITY B	UTILITY C	
	SW3/6	SW3/7	SW3/8	MUSIC SOURCE
DIP SWITCHES	0	0	0	ZONE 1
	0	0	1	ZONE 2
	0	1	0	ZONE 3
	0	1	1	ZONE 4
	1	0	0	LINE 1
	1	0	1	LINE 6

The music level at the Utility/Loop output can be adjusted by the adjacent **MUSIC** preset control. The signal is effectively 'off' with the preset control in its fully anticlockwise position.

The music signal selected for the Utility/Loop output is mixed with a sum of the microphone signals at Mic Input 1 and Mic Input 2, and derived from the Zone 1 preamplifier stage. This applies whether a mic is connected to the **MICROPHONE 1/PAGE MIC** connector or to the **DIGITAL PAGE MIC** port, and ensures that if Mic 1 Input is configured for paging, announcements intended for Zone 1 will be heard via the Utility/Loop output regardless of music source selection.

The level of the mic signal is adjusted with the adjacent **MIC** preset control. The signal is effectively 'off' with the preset control in its fully anticlockwise position. Note that the music content of the signal at the output is NOT altered by Zone 1's front panel **MUSIC LEVEL** control or **MUSIC EQ** preset adjustments, but the mic content will be varied by Zone 1's **MIC 1** and **MIC 2 LEVEL** controls.

Note that mic or music sources from a remote input module connected to the Facility Port are not routed to the Utility/Loop Output.

IMPORTANT: The **UTILITY/LOOP** output is NOT affected by the **MUSIC MUTE** input.

Auxiliary Outputs

The two **AUX OUT** connectors will always carry the signal at the outputs of the preamplifier sections for Zone 1 and Zone 2. Thus the effects of muting, priorities, etc., active in these Zones will be reflected at the auxiliary outputs.

Note also the sources for the Auxiliary Outputs are derived "post" the front panel **MUSIC LEVEL** and **MIC LEVEL** controls, and will therefore be controlled by them, or any remote control plates connected to those Zones.

Auto Power Down

The 46-80 is an extremely energy-efficient mixer-amplifier, but can be made even more so by enabling the Auto Power-Down feature. When active, the signal level is constantly monitored and if no input signals are measured for either 15 or 30 minutes (selectable), the unit enters a "Sleep" mode, minimising power consumption. If an input signal is detected while in Sleep Mode, the mixer-amplifier "wakes up" in less than 450 ms: if the signal is a line input, the volume will be faded up over a period of three seconds.

The 46-80 is shipped with the Auto Power Down function disabled. It may be enabled by setting rear panel DIP switch SW3/1 (**APD ON**) to ON (switch down). Switch SW3/2 (**APD TIMING**) is set to 15M by default, giving a 15 minute delay before entering Sleep Mode: this may be increased to 30 minutes by setting SW3/2 to 30M (switch down).

46-80 SERIAL CONTROL

The 46-80 is equipped with a bi-directional RS-232 serial interface.

As a receiver, the interface permits external control of certain 46-80 settings. These are:

- Music Source selection in each zone
- Music level control in each zone
- MIC 1 muting in each zone
- Global MIC 2 muting (all zones)

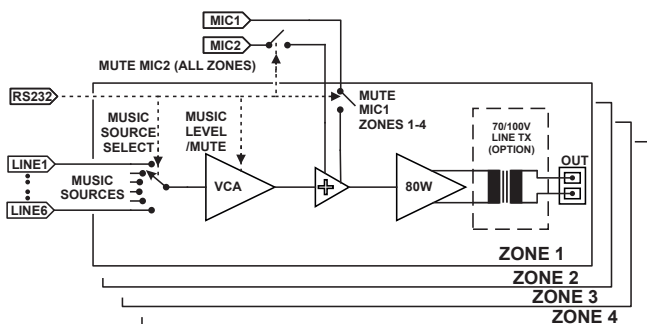

The 46-80 appears as a DCE (Data Communications Equipment) device to controlling equipment. As the controlling device will probably be configured as a DTE device, this requires the use of a straight (uncrossed) cable with the Tx (Data Transmit) pins at the cable ends connected to each other and the Rx pins (Data Receive) similarly connected to each other.

parameter	VALUE/SETTING
Data type:	RS-232 serial
Data speed	9600 baud*
Word length	8 bits
Parity	None
Stop bits	One

*The default baud rate of 9600 baud may be altered by sending the appropriate RS-232 commands; details are in the RS-232 protocol document.

The full RS-232 protocol is beyond the scope of this manual, but is available for download from www.cloud.co.uk.

This section provides only serial port details and an abridged serial command list.

Abridged command set

The commands listed in the table below are some of those most commonly required when controlling a 46-80 from an AV control system. For all other commands, data requests and responses, please refer to the 46-80's full RS-232 protocol document.

GENERAL FORMAT	
FUNCTION	COMMAND (ASCII)
Route Line Input <i>x</i> to Zone <i>y</i>	<Z <i>y</i> .MU, S <i>x</i> />
Set music level in Zone <i>y</i> to <i>-m</i> dB	<Z <i>y</i> .MU, L <i>m</i> />
Reduce music level in Zone <i>y</i> by <i>p</i> dB	<Z <i>y</i> .MU, LD <i>p</i> />
Increase music level in Zone <i>y</i> by <i>q</i> dB	<Z <i>y</i> .MU, LU <i>q</i> />
Mute Mic <i>x</i>	<M <i>x</i> , M/>
Unmute Mic <i>x</i>	<M <i>x</i> , O/>
Access paging in Zone <i>y</i> (see Example 4)	<M1, PA <i>y</i> />
Release paging	<M1, PR/>

Examples:

1. Music source selection:

The values of *x* and *y* in the general format are the Line Input No. (1 to 6) and the Zone No. (1 to 4) respectively.

EXAMPLE	COMMAND (ASCII)	COMMAND (HEX)
Select Input 3 in Zone 2	<Z2.MU, S3/>	3C 5A 32 2E 4D 55 2C 53 33 2F 3E

2. Music levels:

Levels can either be set in a specified zone to an absolute value (in dBs), or increased/decreased by a specified number of dBs. Either may be defined in steps of 1 dB.

For absolute levels, the number of dBs corresponds to attenuation rather than gain, thus 0 dB is maximum level and at -90 dB the zone is muted. The values of *y* in the general format is the Zone No. (1 to 4) and *m* is the attenuation level in one-dB steps (0 to 90) respectively.

To alter the Zone level by a specified amount, the additional ASCII characters 'U' (up) or 'D' (down) are added to the string. The values of *y*, *p* and *q* in the general format are the Zone No. (1 to 4), the level increase in one-dB steps (0 to 90), or the level decrease in one-dB steps (0 to 90) respectively. A command to increment the level by a number of dBs greater than the current attenuation will set the level to maximum. Similarly, a command that would decrement the level below 90 dB attenuation will mute the Zone output.

EXAMPLE	COMMAND (ASCII)	COMMAND (HEX)
Set level in Zone 2 to -12 dB	<Z2.MU,L12/>	3C 5A 32 2E 4D 55 2C 4C 31 32 2F 3E
Reduce level in Zone 1 by 10 dB	<Z1.MU,LD10/>	3C 5A 31 2E 4D 55 2C 4C 44 31 30 2F 3E
Increase level in Zone 4 by 6 dB	<Z5.MU,LU6/>	3C 5A 34 2E 4D 55 2C 4C 55 36 2F 3E

3. Mute/Unmute Mics

Either of the 46-80's two mic inputs may be enabled or disabled. This may be done on a per-zone basis for Mic Input 1, and globally (all zones) for Mic Input 2.

The value of x in the general format is the Mic input (1 or 2).

EXAMPLE	COMMAND (ASCII)	COMMAND (HEX)
Mute Mic 1 in Zone 2 only	<Z2.M1,M/>	3C 5A 32 2E 4D 31 2C 4D 2F 3E
Unmute Mic 1 in Zone 2 only	<Z2.M1,O/>	3C 5A 32 2E 4D 31 2C 4F 2F 3E
Mute Mic 2 globally	<M2,M/>	3C 4D 32 2C 4D 2F 3E
Unmute Mic 1 globally	<M1,O/>	3C 4D 31 2C 4F 2F 3E

4. Enable/Release Paging

RS-232 control of paging allows an audio signal connected at MIC 1 to be routed for paging.

This command differs from the others in that the value of y in the general format is in the form of a 4-character mask of ASCII "X's" (select) and "O's" (don't select), with the character position in the mask denoting the Zone number.

EXAMPLE	COMMAND (ASCII)	COMMAND (HEX)
Access paging for Zone 3	<PM,PAOOXO/>	3C 50 4D 2C 50 41 4F 4F 58 (4F) 2F 3E
Access paging for Zones 1 and 4	<PM,PAXOOX/>	3C 50 4D 2C 50 41 4F 4F 4F 58 2F 3E
Release paging	<PM,PR/>	3C 50 4D 2C 50 52 2F 3E

Note that it is not strictly necessary to transmit the "O" character (4Fh) for channel numbers above the highest being paged. Thus <PM,PAOOX/> (ASCII) would suffice in the first example above. However, the full four characters are shown in the table for completeness, with the extra character in brackets in the hex version.

OPTIONS AND ADDITIONAL INFORMATION

RL-1 and RSL-6 Series remote control plates – general considerations

Cloud RL-1 Series and RSL-6 Series remote control plates are available in two form factors, to fit single-gang UK or American electrical back boxes. Back boxes of either the recessed type or surface-mounting type may be used, providing they are at least 25 mm deep.

The plates should be connected to the **REMOTE MUSIC CONTROL** port of the relevant zone using single- or twin-core screened cable as described on page 18. The plate terminations are conventional screw terminals and the remote **MUSIC CONTROL** port on the mixer is a 3-pin 5 mm-pitch screw terminal connector.

The remote control plates are passive and thus do not draw any current from the mixer.

Control of music source and level via external DC

It may be necessary in some installations to adjust the music level and select music source in one or more zones from an external AV control system. If the **REMOTE MUSIC CONTROL** ports are not required for RL-1/RSL-6 Series remote control plates, they may be used to receive DC voltages from the external system to effect these adjustments.

Both music source selection and level can be controlled over their full ranges with a DC voltage of 0 to +10 V. The pinout of the **REMOTE MUSIC CONTROL** port is as follows:

PIN	USE
1	0 V ref.
2	Music level control (0 to +10 V)
3	Music source selection (0 to +10 V)

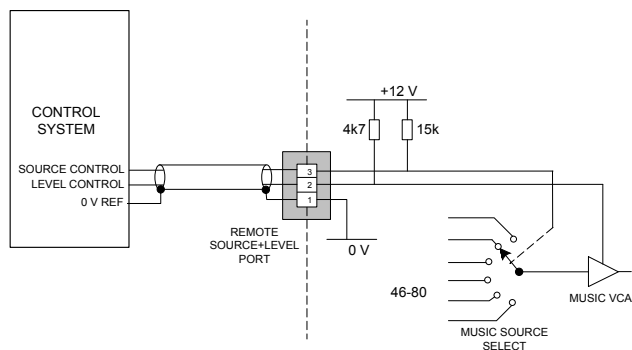

NOTE: If the control voltage source is not isolated from the power earth, there is a small risk of creating a 'ground loop' by linking the mixer technical ground (0 V) to the ground (0 V) of the equipment supplying the control voltages. To

minimise this risk, we suggest that all pieces of equipment be in close proximity, and supplied from the same power outlet.

Music level

Music level in a zone may be varied over its full range by applying a DC voltage of between 0 V and +10 V to pin 2, the 0 V reference being connected to Pin 1. 0 V on pin 2 corresponds to maximum level and +10 V will produce 60 dB of attenuation. The rate of attenuation is approximately 165 mV/dB.

Note that there is an internal 4k7 "pull-up" resistor between pin 2 and the internal +12 V rail. If pin 2 is left "floating", this pull-up will result in full attenuation. The output impedance of the control voltage source should be low enough to overcome the effect of this resistor.

Music source

Music source for a zone may be controlled by applying various DC voltages of between 0 and +10 V to pin 3, the 0 V reference being connected to pin 1. 0 V at pin 3 will select Line input 6 and between +6 V and +7.2 V will select Line input 1. The other line inputs will be selected with intermediate voltages. Taking pin 3 above +7.2 V will deselect all inputs, making the zone effectively 'off' for music.

The table below lists the DC voltages required at pin 3 to select each line input. The third column is the value of a resistor which should be connected between pins 1 and 3 to permanently 'force' a zone to a particular line input.

INPUT	DC VOLTAGE	RESISTOR VALUE
OFF	>+7.2 V	Open-circuit
Line 1	+6.0 V	16k
Line 2	+4.8 V	10k
Line 3	+3.6 V	6k8
Line 4	+2.4 V	3k9
Line 5	+1.2 V	1k8
Line 6	0 V	short-circuit

Note that there is an internal 15k "pull-up" resistor between pin 3 and the internal +12 V rail. If pin 3 is left "floating", this pull-up will cause 'OFF' to be selected. The output impedance of the control voltage source should be low enough to overcome the effect of this resistor.

Using the Facility Port as an auxiliary zone input

The Facility Port provides a balanced audio input to Zone 1. If the port is not connected to an active remote module, it may be used as a direct input to Zone 1 from other equipment forming part of the system (for example, a permanently installed DJ mixer which only ever needs to route its output to Zone 1).

Wire an external balanced source to the facility port as shown below:

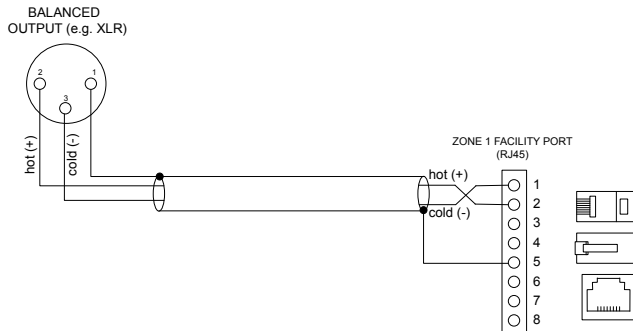

An unbalanced source may also be connected; the use of balancing transformers is recommended.

Fitting CXL-80T transformers

NOTE: Full installation instructions are included with the transformer. The notes below are an abridged version.

The CXL-80T transformer allows Model 46-80 to be used with 70/100 V-line loudspeaker systems. One transformer will be needed for each Zone output to be configured for 70/100 V-line operation.

1. Disconnect the 46-80 from the mains and remove the top cover.
2. With the rear panel facing you, fit the transformers to the right-hand chassis side using the M4 x 45 bolts supplied. Four M4 holes are provided in the side panel for this purpose.
3. Each transformer terminates in one 2-pin and one 3-pin connector. The 2-pin one (black/red) is the input, the 3-pin one (blue/purple/white) is the output.
4. Identify the power amplifier section feeding the Zone Output to be converted: this is easily done by tracing the blue/white twisted pairs back from the **SPEAKER OUTPUT** connector. Unplug both ends of the twisted pair and remove
5. Plug the 2-pin connector from the transformer into the header on the power amplifier board now vacated.
6. Plug the other connector from the transformer onto the corresponding 3-pin header behind the **SPEAKER OUTPUT** connector. There are two per Zone Output: those nearer the rear panel are for 100 V-line operation, the other set is for 70 V-line operation.
7. Enable the 65 Hz high-pass filters for the relevant channels (J3, J4, J5 & J6). See page 30 for jumper locations.
8. Replace the cover.
9. Do not re-power the 46-80 until the external speaker connections have been made and the safety cover refitted over the **SPEAKER OUTPUT** connector. After connecting the 70/100 V-line loudspeaker system (see page 20), fit the blanking plate from Step 2 onto the hex spacers (Step 8) over the connector, with the printed warnings outwards.

PCB jumper locations

The 46-80 has various internal jumpers, the setting of which may require alteration during installation. The diagram below shows the locations of the internal jumpers (not to scale) on the internal PCBs, and the table below lists each jumper and its purpose, together with the factory default setting.

Note that the 46-80 has several PCBs. One of these, the upper PCB (mounted inside the rear panel) carries two jumpers (J1 and J2), but all other jumpers are on the main PCB.

All "user" jumpers have two possible positions; the black square in the symbol on the diagram below indicates the default setting. If any jumpers need to be changed, turn the 46-80 off and disconnect it from the mains. Undo the eight screws securing the top cover of the unit and remove it. Use a pair of small pliers to gently remove the jumpers from the PCB headers and reposition them as required. Refit the top cover using the same screws.

The PCB diagram (which is as viewed from the rear of the unit) also shows the locations of the headers relevant to retrofitting one or more CXL-80T transformers (see page 29).

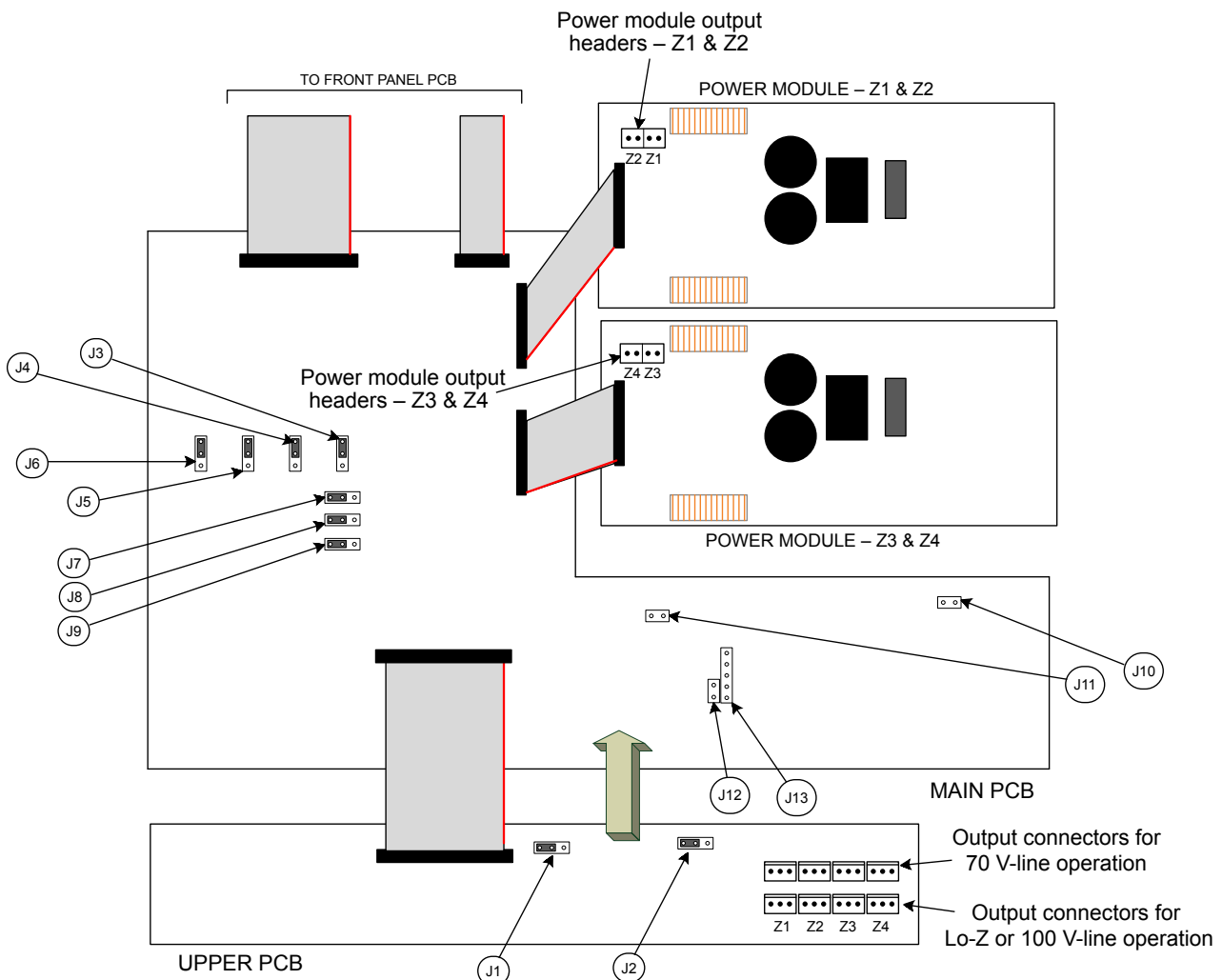

Table of internal jumpers and default settings

The table below lists each jumper and its purpose, together with location and factory default setting.

JUMPER	PCB	DESCRIPTION	EFFECT	DEFAULT
J1	Upper	CDPM bus termination	ALWAYS ON – DO NOT MOVE	ON
J2	Upper	Mic-over-Facility port priority	OFF: Mic signals will be mixed at full level with Facility Port input ON: An input at Mic 1 or Mic 2 will cause a signal from the Facility Port to duck	OFF
J3	Main	Zone 1 65 Hz High Pass Filter	OFF: full frequency response ON: 65 Hz hi-pass filter enabled for Zone 1	OFF*
J4	Main	Zone 2 65 Hz High Pass Filter	OFF: full frequency response ON: 65 Hz hi-pass filter enabled for Zone 2	OFF*
J5	Main	Zone 3 65 Hz High Pass Filter	OFF: full frequency response ON: 65 Hz hi-pass filter enabled for Zone 3	OFF*
J6	Main	Zone 4 65 Hz High Pass Filter	OFF: full frequency response ON: 65 Hz hi-pass filter enabled for Zone 4	OFF*
J7	Main	Power amp Z2 input source	D: Power amp Z2 is fed from Z2 pre-amp R: Power amp Z2 is fed from Z1 pre-amp	D
J8	Main	Power amp Z3 input source	D: Power amp Z3 is fed from Z3 pre-amp R: Power amp Z3 is fed from Z1 pre-amp	D
J9	Main	Power amp Z4 input source	D: Power amp Z4 is fed from Z4 pre-amp R: Power amp Z4 is fed with source selected by J7	D
J10	Main	APD Test Mode	FOR FACTORY USE ONLY - DO NOT FIT A JUMPER	
J11	Main	NVM Reset	Restores factory settings	
J12	Main	Spare	FOR FACTORY USE ONLY - DO NOT FIT A JUMPER	
J13	Main	Programming header	FOR FACTORY USE ONLY - DO NOT FIT A JUMPER	

*These jumpers are factory-set to ON in Model 46-80T.

Restoring factory settings

If it is necessary to restore the 46-80's settings to their original factory defaults, temporarily fit a jumper to the J11 header and power-cycle the unit. Remove the temporary jumper before replacing the lid.

Summary of rear panel DIP switch functions

(Factory default settings are in **BOLD** text.)

DIP SWITCH SW1		POSITION	FUNCTION
1	MIC 1 PHANTOM POWER	OFF = MIC 1 PHANTOM POWER OFF	No phantom power at MICROPHONE 1 / PAGE MIC input.
		OFF = MIC 1 PHANTOM POWER ON	15 V phantom power available at MICROPHONE 1 / PAGE MIC input.
2	MIC 2 PHANTOM POWER	OFF = MIC 2 PHANTOM POWER OFF	No phantom power at MICROPHONE 2 input.
		OFF = MIC 2 PHANTOM POWER ON	15 V phantom power available at MICROPHONE 2 input.
3	MIC OVER MUSIC	OFF = NO PRIORITY	No priority – both mics mix with music
		OFF = PRIORITY ON	Music ducks when either mic is in use
4	MUTE – N/O OR N/C	N/O = NORMALLY OPEN CONTACTS	External contact closure required for muting
		N/C = NORMALLY CLOSED CONTACTS	External contact opening required for muting
5	PAGING MODE	MIC = MIC MODE	Both Mic Inputs function as standard microphone inputs, including GAIN and LEVEL controls.
		PG = PAGE MODE	Mic 1 input functions as a typical Cloud paging input: connect a paging mic to either the MICROPHONE 1 / PAGE MIC input (select zones using the MIC 1 ACCESS port), or via the DIGITAL PAGE MIC port.
DIP SWITCH SW2		POSITION	FUNCTION
1	Z1 LEVEL	LOC = LOCAL CONTROL OF Z1 MUSIC LEVEL	Music level in Zone 1 is set by the front panel ZONE 1 MUSIC LEVEL control.
		REM = REMOTE CONTROL OF Z1 MUSIC LEVEL	Music level in Zone 1 is controlled by a remote plate/module connected to the REMOTE MUSIC CONTROL port (ZONE 1), or via RS232 commands.
2	Z1 SOURCE	LOC = LOCAL SELECTION OF Z1 MUSIC SOURCE	Music source in Zone 1 (Line 1 to Line 6) is selected by the front panel ZONE 1 MUSIC SOURCE control.
		REM = REMOTE SELECTION OF Z1 MUSIC SOURCE	Music source in Zone 1 (Line 1 to Line 6) is selected on a remote plate/module connected to the REMOTE MUSIC CONTROL port (ZONE 1), or via RS232 commands.
3	Z2 LEVEL	LOC = LOCAL CONTROL OF Z2 MUSIC LEVEL	Music level in Zone 2 is set by the front panel ZONE 2 MUSIC LEVEL control.
		REM = REMOTE CONTROL OF Z2 MUSIC LEVEL	Music level in Zone 2 is controlled by a remote plate/module connected to the REMOTE MUSIC CONTROL port (ZONE 2), or via RS232 commands.
4	Z2 SOURCE	LOC = LOCAL SELECTION OF Z2 MUSIC SOURCE	Music source in Zone 2 (Line 1 to Line 6) is selected by the front panel ZONE 2 MUSIC SOURCE control.
		REM = REMOTE SELECTION OF Z2 MUSIC SOURCE	Music source in Zone 2 (Line 1 to Line 6) is selected on a remote plate/module connected to the REMOTE MUSIC CONTROL port (ZONE 2), or via RS232 commands.
5	Z3 LEVEL	LOC = LOCAL CONTROL OF Z3 MUSIC LEVEL	Music level in Zone 3 is set by the front panel ZONE 3 MUSIC LEVEL control.
		REM = REMOTE CONTROL OF Z3 MUSIC LEVEL	Music level in Zone 3 is controlled by a remote plate/module connected to the REMOTE MUSIC CONTROL port (ZONE 3), or via RS232 commands.
6	Z3 SOURCE	LOC = LOCAL SELECTION OF Z3 MUSIC SOURCE	Music source in Zone 3 (Line 1 to Line 6) is selected by the front panel ZONE 3 MUSIC SOURCE control.
		REM = REMOTE SELECTION OF Z3 MUSIC SOURCE	Music source in Zone 3 (Line 1 to Line 6) is selected on a remote plate/module connected to the REMOTE MUSIC CONTROL port (ZONE 3), or via RS232 commands.
7	Z4 LEVEL	LOC = LOCAL CONTROL OF Z4 MUSIC LEVEL	Music level in Zone 4 is set by the front panel ZONE 4 MUSIC LEVEL control.
		REM = REMOTE CONTROL OF Z4 MUSIC LEVEL	Music level in Zone 4 is controlled by a remote plate/module connected to the REMOTE MUSIC CONTROL port (ZONE 4), or via RS232 commands.
8	Z4 SOURCE	LOC = LOCAL SELECTION OF Z4 MUSIC SOURCE	Music source in Zone 4 (Line 1 to Line 6) is selected by the front panel ZONE 4 MUSIC SOURCE control.
		REM = REMOTE SELECTION OF Z4 MUSIC SOURCE	Music source in Zone 4 (Line 1 to Line 6) is selected on a remote plate/module connected to the REMOTE MUSIC CONTROL port (ZONE 4), or via RS232 commands.

DIP SWITCH SW3		POSITION	FUNCTION
1	APD ON	OFF = APD MODE OFF	46-80 remains in Active Mode unless unpowered.
		ON = APD MODE ENABLED	46-80 will enter Sleep Mode if no input signals are detected for the period set by SW3/2.
2	APD TIMING	15M = 15 MINS DELAY	If SW3/1 is set to ON, 46-80 will enter Sleep Mode if no input signals are detected for 15 minutes.
		30M = 30 MINS DELAY	If SW3/1 is set to ON, 46-80 will enter Sleep Mode if no input signals are detected for 30 minutes.
3	LINE 6 PRIORITY Z1	OFF = PRIORITY OFF	Music Source in Zone 1 will always be that selected by the front panel ZONE 1 MUSIC SOURCE control (SW2/2 = LOC), or by a remote control plate/module connected to the REMOTE MUSIC CONTROL port (ZONE 1), or via RS232 commands (SW2/2 = REM).
		ON = PRIORITY ON	A signal applied to Line Input 6 will automatically replace the current music source selection for Zone 1.
4	LINE 6 PRIORITY ALL	OFF = PRIORITY OFF	Music Source in all Zones will always be that selected by the respective front panel MUSIC SOURCE controls (SW2/2, 4, 6 or 8 = LOC), or by a remote control plate/module connected to the REMOTE MUSIC CONTROL port, or via RS232 commands (SW2/2, 4, 6 or 8 = REM).
		ON = PRIORITY ON	A signal applied to Line Input 6 will automatically replace the current music source selection in all Zones.
5	(UNUSED)		
6	UTILITY SOURCE A	These switches are used in combination to select the music source for the UTILITY/LOOP output. Options are: Zones 1 to 4, Line 1 or Line 6.	Refer to Music Source selection table at Page 25 (also on lid of unit).
7	UTILITY SOURCE B		
9	UTILITY SOURCE C		

EMC considerations

The Cloud 46-80 fully conforms to the relevant electromagnetic compatibility (EMC) standards and is technically well behaved; you should experience no operational problems and under normal circumstances, no special precautions need to be taken. If the unit is to be used within close proximity to potential sources of HF disturbance such as high power communications transmitters, radar stations and the like, the performance of the mixer may be reduced; we suggest that all microphone and line input cables are kept as short as possible.

Ground loops

If, despite your best efforts, the completed sound system 'hums' you probably have a 'ground loop'. The offending signal source can often be identified by setting the volume control to minimum, then disconnecting the input leads (both left & right channels) on each line input until the 'hum' disappears. This problem is often caused by terminating a screened input cable into a signal source positioned a significant distance from the mixer. A good way of avoiding this potential problem is to use signal sources (typically 'consumer' equipment) that are double insulated with no connection to the mains supply earth. If a signal feed were derived from a second mixer (a club or microphone mixer for example) it would be perfectly normal to expect this to be earthed; we suggest that a transformer be used to isolate the signal and prevent a noisy loop (see page 15).

TECHNICAL SPECIFICATIONS

Technical specifications

Line Inputs 1 & 2 (unbalanced)		
Frequency Response	±0.5 dB, 20 Hz to 20 kHz	
THD + N	<0.02%, 1 kHz sine wave	
Sensitivity	195 mV (-12 dBu) to 2.0 V (+8 dBu)	
Gain control range	-10 dB to +10 dB	
Input Impedance	10.2 kohms	
Headroom	17 dB	
Noise	<-88.5 dB (nominal gain, max level, 22 Hz to 22 kHz)	
Line Inputs 3 to 6 (balanced)		
Frequency Response	-0.5 dB @ 20 Hz; -0.5 dB @ 20 kHz	
THD + N	<0.015%, 1 kHz sine wave	
Sensitivity	195 mV (-12 dBu) to 2.0 V (+8 dBu)	
Gain control range	-9 dB to +11 dB	
Input Impedance	10.2 kohms	
Headroom	17 dB	
Noise	<-88.5 dB (nominal gain, max level, 22 Hz to 22 kHz)	
Microphone Inputs		
Frequency Response	-6 dB @100 Hz (fixed filter) to ±1 dB @ 20 kHz	
THD + N	<0.05%, 1 kHz sine wave	
Gain Range	10 dB to 48 dB	
Common mode rejection	<58 dB @ 1 kHz	
Input Impedance	3.3 kohms (balanced)	
Headroom	18 dB	
Noise (EIN)	-127.2 dB; 22 Hz to 22 kHz, maximum gain, Rs = 150 ohms	
Phantom Power	15 V, individually selectable	
Equalisation	HF: ±10 dB @ 5 kHz; LF: ±10 dB @ 100 Hz	
Main Outputs		
Low Impedance Outputs (Model 46-80)	80 W into 4 ohms	
High Impedance Outputs (Model 46-80T)	100 V operation	80 W constant voltage into 125 ohm minimum load
	70 V operation	70.7 W constant voltage into 62.5 ohm minimum load
Amplifier protection	Fixed level signal limiter, protection against DC, over current, over temperature	
Cooling	Natural convection	
Utility/loop Output		
Frequency Response	±0.5 dB, 20 Hz to 20 kHz	
THD + N	<0.01% @ 1 kHz	
Nominal level	0 dBu (0.775 V _{rms})	
Aux Outputs (Zones 1 & 2)		
Frequency Response	±0.5 dB, 20 Hz to 20 kHz	
THD + N	<0.05% @ 1 kHz	
Nominal level	0 dBu balanced (0.775 V _{rms})	

General		
Power input	85 to 243 VAC, 47 to 63 Hz	
Normal operating temperature	0 °C to 35 °C (Note: performance and specifications cannot be guaranteed outside of this range)	
Power consumption	Standby ¹	8.6 W, 27.5 VA
	Idle ²	20.3 W, 38.6 VA
	1/8 th Power ³	Lo-Z output (4 ohms): 64.9 W, 85.2 VA
		Hi-Z output (100 V into 125 ohms): 92 W, 109.7 VA
1/3 rd Power ⁴	Lo-Z output (4 ohms): 126 W, 154 VA	
	Hi-Z output (100 V into 125 ohms): 176 W, 198 VA	
Heat Loss	Standby ¹	30.8 kJ/hr (29 BTU/hr)
	Idle ²	72 kJ/hr (69 BTU/hr)
	1/8 th Power ³	Lo-Z output (4 ohms): 103 kJ/hr (98 BTU/hr)
		Hi-Z output (100 V into 125 ohms): 187 kJ/hr (177 BTU/hr)
1/3 rd Power ⁴	Lo-Z output (4 ohms): 129 kJ/hr (122 BTU/hr)	
	Hi-Z output (100 V into 125 ohms): 287 kJ/hr (272 BTU/hr)	
Dimensions	Net	482.6 mm x 88 mm (2U) x 320 mm 19" x 3.5" x 12.6"
	Shipping (Gross)	610 mm x 200 mm x 460 mm 24" x 8" x 18"
Weights	Net	46-80: 5.5 kg / 12.3 lbs
		46-80T: 8.6 kg / 19.3 lbs
	Shipping (Gross)	46-80: 8 kg / 17.9 lbs
		46-80T: 11.1 kg / 24.9 lbs

Notes re Power Consumption and Heat Loss measurements:
All measurements at 230 VAC 50 Hz power input

1. Standby: amplifier in standby state (STATUS LED steady red)
2. Idle: amplifier not in standby state (STATUS LED steady green), but no audio output
3. 1/8th. Power: constant sound level at 10 W output (audio mainly clean, only occasional clipping)
4. 1/3rd. Power: constant sound level at 27 W output (audio beginning to become compressed, limited or heavily clipped)

www.cloud.co.uk



www.cloudusa.pro

MADE IN BRITAIN 